

SANDVIK TOP HAMMER ROCK DRILLING TOOLS



PRODUCT CATALOGUE
SANDVIK MINING



AT SANDVIK WE PUT SAFETY FIRST

With continued demand from mining companies to ensure safety and increase productivity, Sandvik rock tools are committed to providing the support needed – through safe products and product information.

Every site must work with environmental health and safety (EHS) Regulations. EHS procedures should be developed specifically for the operation. All those involved should collect and apply those procedures throughout their work, while constantly examining if they are adequate enough or need modifications. A methodology of risk assessments should be employed.

PERSONAL SAFETY MEASURES

APPROPRIATE PERSONAL PROTECTIVE EQUIPMENT (PPE) SHOULD BE WORN (E.G.):

- ▶ Safety helmet
- ▶ Hearing protection
- ▶ Safety glasses
- ▶ Protective and high visibility clothing
- ▶ Safety boots

TAKE 5 MINUTES

Consider safety when planning your Schedule. Taking five minutes before the start of a task to consider the possible hazards, perform a quick risk assessment and then plan and apply appropriate control measures is a quick and effective way to prevent incidents that can cause injury and environmental damage.

Plan, sequence and determine the resources required for each step of the job. Consult available procedures.

Identify potential hazards, determine the risk of the hazards and consider appropriate measures to control the hazards. Ensure you have the correct resources to perform the task.



RECOMMENDED SAFETY PROCEDURES

LIFTING PROCEDURES

Use safe and correct lifting practices while working with heavy items. Consider body position, awkwardness of the item and its weight. Are two people required for the lift, is a lifting device necessary?

GRINDING OF BITS

Drill bits have cemented carbide buttons. Cemented carbide is made up of tungsten carbide and cobalt. Grinding buttons will produce dusts or fumes with dangerous ingredients that can be inhaled, swallowed or come in contact with the skin or eyes. Do not breathe dust. Wear protective gloves/protective clothing/eye protection. In case of inadequate ventilation wear respiratory protection. In particular, avoid dry grinding. For more information see page 99.

ASSEMBLY OF BITS

- ▶ Do not touch any equipment whilst it is rotating.
- ▶ The rod rotation must be stopped before installing or removing a drill bit.
- ▶ Follow site instructions for isolation of rotation motors.
- ▶ Beware of pinch points between the bit and the rod.

DRILLING WITH HANDHELD EQUIPMENT

Sandvik rock tools are designed and manufactured to the highest standards. A particular hazard exists with handheld drilling equipment, where if the drill rod breaks it can form an impalement hazard if the broken drill steel protrudes from the hole it was drilling, whilst the driller is pushing towards the broken drill steel.

DISASSEMBLY OF HOT BIT, ROD, COUPLING, SLEEVE, SHANK-ADAPTER AND INTEGRAL STEEL

- ▶ Ensure products have cooled down before disassembling.
- ▶ Never work on hot parts.
- ▶ Consider appropriate hand protection (gloves) for handling warm parts.



CLEANING OF RODS

A particular hazard exists with cleaning rods if the rods contain explosives. Sandvik rock tools should never be used in a hole that has been filled with explosive.

DEALING WITH WORN PARTS

Worn parts should be removed and disposed of appropriately. Consider recycling the used drill bits. Please contact your local Sandvik Mining representative for support and further information regarding the recycling process.

STORING

All products should be stored in a dry place and in original package until they are required for use.

GENERAL

The products in this catalog are designed for drilling holes in rock and should only be used for this purpose.

Read more about our Health and Safety Information at page 99.



Göran Fredrik Göransson founded Sandvik in 1862.

AS THE WORLD CHANGES OUR VALUES REMAIN THE SAME

With 150 years of history it's not surprising that we have seen many changes in our industry. What hasn't changed is our commitment to our core values Open Mind, Team Spirit and Fair Play. By living our values we are an innovative and growing company, meeting the world around us with an open mind.

We pride ourselves in developing and offering the very best solutions for our customers. A major breakthrough for us here at Sandvik was the integral steel in the late 1940's. Overnight, this material revolutionised rock drilling a hundredfold and significantly improved production as well as performance. This Integral drill steel was the first

product that was based on the new revolutionary material, cemented carbide and is still the single most important material that makes rock drilling effective and profitable for our customers. Today, we continue to conduct business in close cooperation with our customers, based all over the world. We stand by our promise of being a proactive and innovative partner. We accomplish this by always looking ahead, listening to our customers and their market requirements. We follow developments in society and industry, as well as contributing products and solutions to meet demand.

SMALL HOLE DRILLING	17
DRIFTING AND TUNNELING	31
BENCH DRILLING	47
LONG HOLE DRILLING	61
SHANK ADAPTERS	75
AUXILIARY TOOLS	95
INFORMATION	99
INDEX	104
NOTES	110

.....

“In a world where innovation and technology make the difference between good work and great work, being second best just isn’t an option for us.”

.....

OUR VALUES ARE REPRESENTED IN THE WAY WE DO BUSINESS

Sandvik Mining is a leading global supplier of Rock tools and equipment, service and technical solutions for the mining industry. Our offering covers rock drilling, rock cutting, rock crushing, loading and hauling and materials handling.

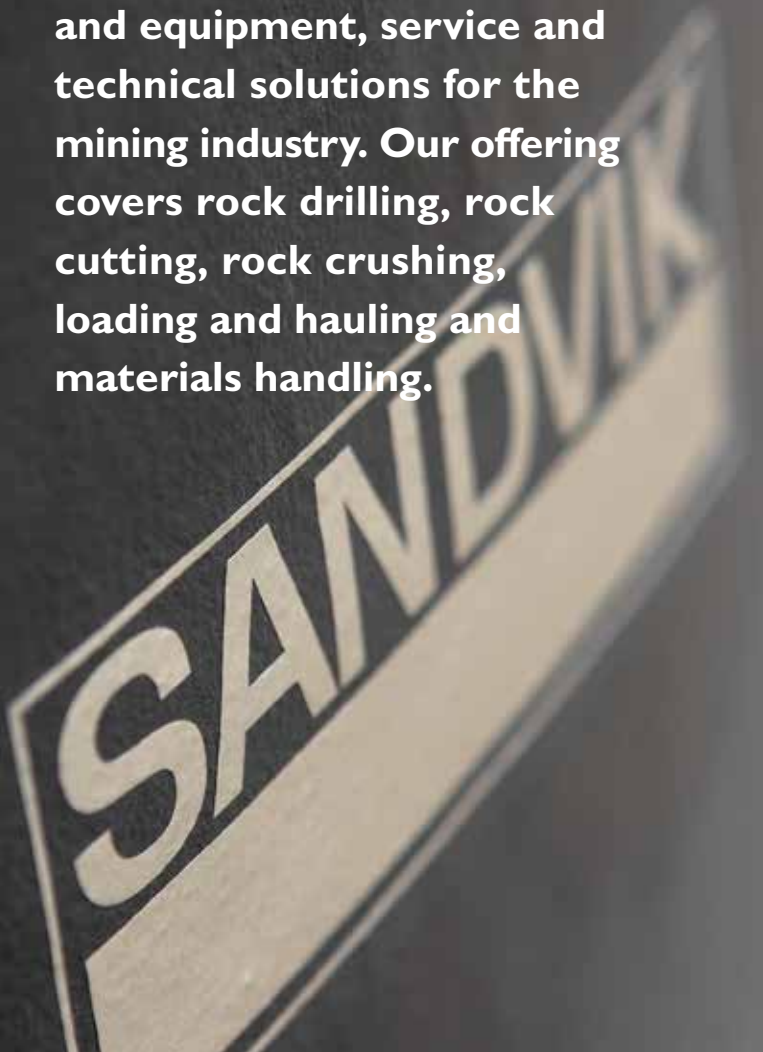

► OPEN MIND

At Sandvik, we approach the world around us with an open mind to remain a highly innovative and growing company focused on increasing value for our stakeholders. Open Mind invites us to look for innovations and improvements, to value and learn from different perspectives and to take a positive attitude to change. We encourage those who take the initiative and experiment with new ways of working.

► TEAM SPIRIT

Within the Sandvik Group, we act together as one team in close cooperation with our stakeholders worldwide. Progress is secured by Sandvik personnel trusting each other as enthusiastic members of a team, with everyone seeking to do their best and showing respect for one another.

► FAIR PLAY

At Sandvik, Fair Play is about taking our responsibilities when conducting business. We comply with the high ethical standards stated in the Sandvik Code of Conduct. This means that our business is based on honesty, integrity and trust. Fair Play also requires us to conduct transparent relations with all of our stakeholders.



Continuous improvement – product quality and service is our only job. We believe “there is no best, only better”.



RESEARCH AND DESIGN TAKE THE LEAD IN OUR PRODUCTION

Our rock tools are known to all the main mining customers all over the world.

Our tight focus and continuous development work insure the latest technical solutions for the most demanding rock conditions and for the most powerful rock tools, all for the benefit of our customers.

Our products undergo extensive laboratory studies and then, tested fully in the field. Finally evaluated and refined to provide the highest grade of equipment that stands for the Sandvik name.

Our spirit of innovation and high involvement runs through every product. It is preceded by extensive Research & Development. Supported by a worldwide service network offering on-site service, training and round-the-clock support.

Our service-oriented, global organisation is well developed. Sandvik has technical service specialists strategically located around the world to service our customers.



AT SANDVIK SAFETY IS NOT HANDLED LIGHTLY

Safety is also very important for our customers. We are the safe choice for our customers, not only because we lead in safety innovation and functional safety, but also because we do what we promise. In addition to offering our customers' better productivity, Sandvik products and services also enable them to sleep well at night. The reason? Risk is minimised, enabling operations to run smoothly, giving them peace of mind.

WE BRING QUALITY TO EVERY PRODUCT WE DELIVER



At Sandvik, we take pride in having full control of each processing step and in developing proprietary production processes that further improve our technological capabilities. With production, research and development in-house for the essential key materials for manufacturing rock drilling tools, we continue to develop new products and new cemented carbide grades that enhance our customers' operations through superior performance and reduced costs.

An extensive research project within Sandvik has resulted in a new generation of carbide grades and new larger, stronger, more stable and efficient tools.

This latest generation of carbide grades is manufactured using our own innovative process techniques, with completely new raw materials. With a significantly stronger carbide matrix and a perfect grain size configuration, we are able to deliver superior toughness and high wear temperature resistance to meet the needs of a great number of our customers operations.

A NEW GENERATION IN CEMENTED CARBIDE

With new manufacturing techniques, the XT48 cemented carbide has gained greater density and a more homogenous structure. Toughness has been increased without compromising the exceedingly high wear resistance – making the material stronger, without sacrificing its hardness.



The gauge buttons of a drill bit are exposed to axial forces. Sandvik's former cemented carbides have always been able to handle that type of load with minimal risk of breakage.



When the bit wears, the load angle changes and the risk for button breakage increases. The XT48 cemented carbide has significantly higher resistance to that type failure.

SANDVIK GRADE XT48 BIT

- ▶ Optimised cutting structure
- ▶ Ballistic or super spherical buttons
- ▶ XT48 grade carbide
- ▶ Deep flushing grooves with optimal positioning
- ▶ Optimised wing / head design

WORLD CLASS STEEL PRODUCTION

Sandvik's rolling mill for hollow drill steel is the most up-to-date in the world. Fully automated, this unique mill is designed specifically for manufacturing this product. After rolling, the rods are turned to avoid decarburisation in the final rolling process. A long, straight centre hole is drilled in the drill steel blank and a core is inserted. The blanks are hot-rolled into a round or hexagon-shape. A carefully controlled cooling process after rolling guarantees uniform mechanical properties. The core is then removed and the drill steel is ready for shipping.



SANDVIK ALPHA, FEATURES AN ENTIRELY NEW THREAD DESIGN

The benefits of short threads on hexagonal drill rods are superior resistance to bending stresses, improved bit guidance and outstanding energy transfer. The sturdy thread is well supported inside the bit skirt, resulting in high precision collaring – even in complex rock formations and against uneven surfaces.



MF-DESIGN GIVES STRAIGHTER HOLES

Male-Female (MF) drill rods provide a more rigid drill string than one using extension rods and couplings. This is due to a 50% reduction in thread play of the MF rod connections vs. coupling connections. Drilling with a stiffer drill string results in improved hole straightness, improved efficiency and safety.



STRAIGHT, FAST AND SETTING THE INDUSTRY STANDARD

Compared to the T51 drill rods, GT60 rods have a 40% larger rod cross-section and a 65% higher bending resistance. These improvements double the life of the drill rods and shank adapter. As an added bonus, the rigidity of the GT60 drill rods permit optimum drilling patterns and higher rates of penetration.

PROCESSES IN ROD MANUFACTURING

CARBURISATION

- ▶ Case hardening in a furnace with carbon rich gas
- ▶ Increased carbon content in outer layer hardens material

INDUCTION SURFACE HARDENING (HF) + THREADS

- ▶ Hard wear resistant surface
- ▶ Improved fatigue strength
- ▶ Induction hardening of thread
- ▶ Rapidly heated and cooled

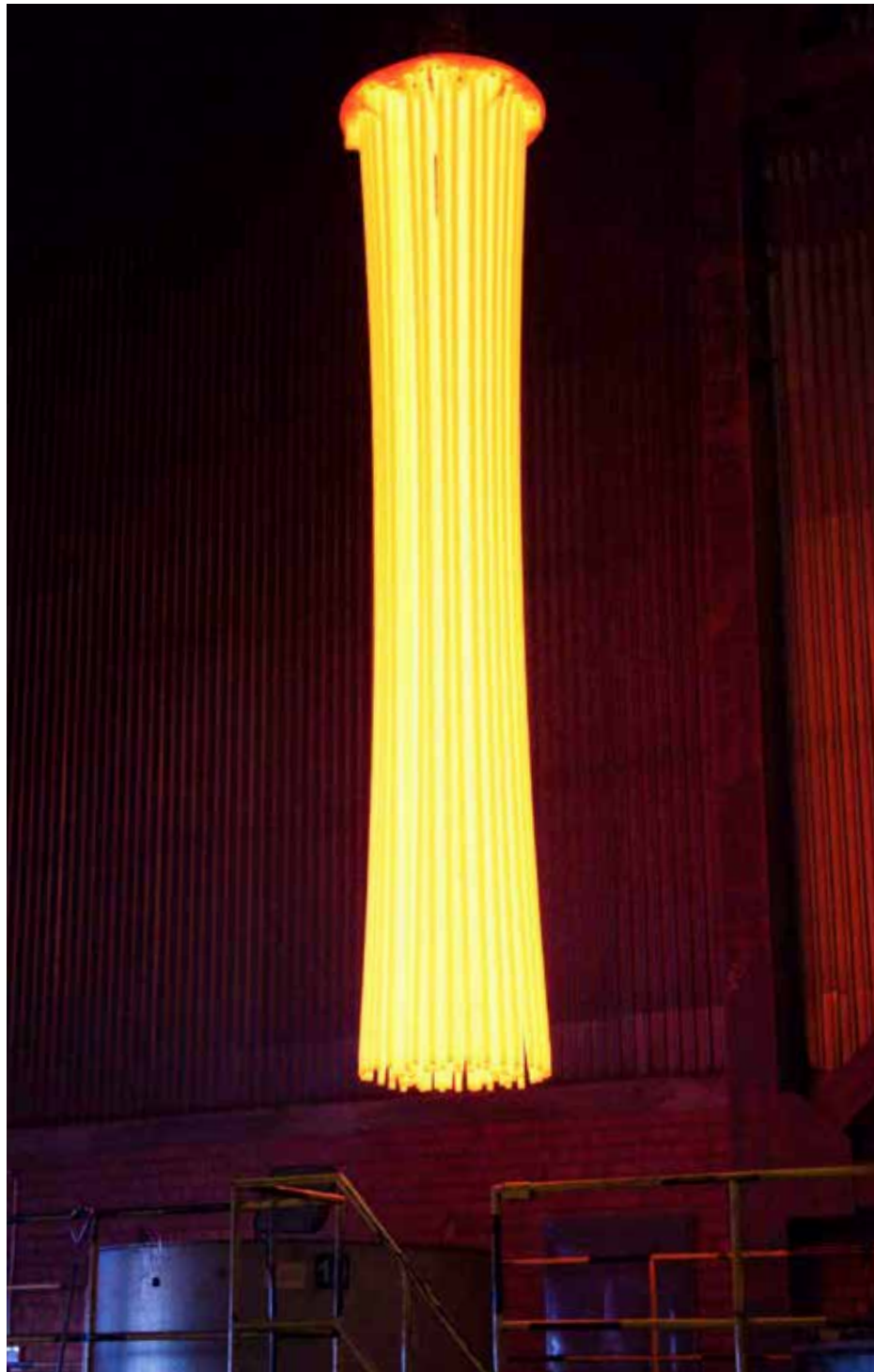

TWO OF OUR LATEST DEVELOPMENTS BRING GREATER PRODUCTIVITY



SANDVIK DEMONSTRATES ITS POWER

The quality of the holes drilled by a Sandvik DPI 100 top-hammer rig, with an HLI560T rock drill, was found to be significantly better than those drilled by a competitor's high-pressure, high-volume down-the-hole drill. Utilising an 87 mm diameter, 4.3 m GT60 pilot tube, GT60 4.3 m extension rods, 115 mm ballistic Retrac bits, and HLI560T shank adapters. Holes were drilled in granite to a depth of 20 m and at an angle of 15°. Fuel consumption of the Sandvik DPI 100 was significantly lower than the DTH Drill, 42 liters/hr vs. 78 liters/hr.

The Sandvik GT60 bits has been created in our unique engineering, manufacturing and facility. This has enabled us to tailor the characteristics of the bits to match almost any drilling conditions.

SIX REASONS WHY THE GT60 WORKS FOR YOUR BUSINESS

- ▶ **1.** The steel in Sandvik *GT60* rods is produced in one of the world's most advanced continuous casting plants. Almost 90 years of experience of rolling hollow bar steel, has made Sandvik unique in being able to produce steel with close tolerances and excellent material properties.
- ▶ **2.** The Sandvik *GT60* system includes Sandvik button bits to comply with all kinds of rock formations and drilling site conditions.
- ▶ **3.** The Sandvik *GT60* system provides double the penetration rate, consuming half the energy compared with DTH drilling.
- ▶ **4.** The Ø 60 mm rod cross-section is optimised for high-energy transfer of impact power in top hammer drilling of Ø 92 to 152 mm holes. Compared with 51 mm rods, the 40% larger cross-section and 65% higher bending stiffness permit faster penetration rates and straighter holes.
- ▶ **5.** Sandvik *GT60* is perfectly suitable for automatic rod handling systems. Male and female (MF) threads minimise energy losses and simplify handling.
- ▶ **6.** The large flushing holes provides superior removal of cuttings and improves drilling performance. The exact centring of the hole during manufacture ensures uniform steel walls and uniform product performance.



THE SANDVIK BITS DOUBLES SERVICE LIFE AROUND THE WORLD

Great versatility, higher penetration rates, straighter holes, longer bit life and lower energy consumption. That's what you can expect from the Sandvik bits. An exceptionally versatile series of threaded button-bits from 28–152 mm in diameter. The buttons are made from proprietary grades of cemented carbide. Sandvik provides all the best button shapes (spherical, conical or ballistic) and the required skirt designs (regular or retrac) in order to obtain the best bit for the rock formation in question.

.....

“If button failure is a problem in your rock formation, then certainly you will see a big increase in bit life with Sandvik rock tools.”

.....

EXCEEDING EXPECTATIONS

Sandvik Alpha bits exceeded the mine average by 25% in Canada. This figure includes bit damage during uncoupling, but after corrections in procedures the bit performed over 50% above the mines average in very hard abrasive rock. The new bits could also be regrinded 5–7 times compared to 3–4 with the old standard.

Drifter bit service life was proven to be at least 20% higher than competition in a Swedish mine.

SERVICE LIFE DOUBLES

Management at an Australian mine, welcomed the news of higher productivity and lower costs. Long notorious for button breakages, Sandvik Alpha drill bits are giving almost double the service life compared to drill bits used previously. In a large-scale test, stoppages are down; productivity is up while bit costs have been cut by half.

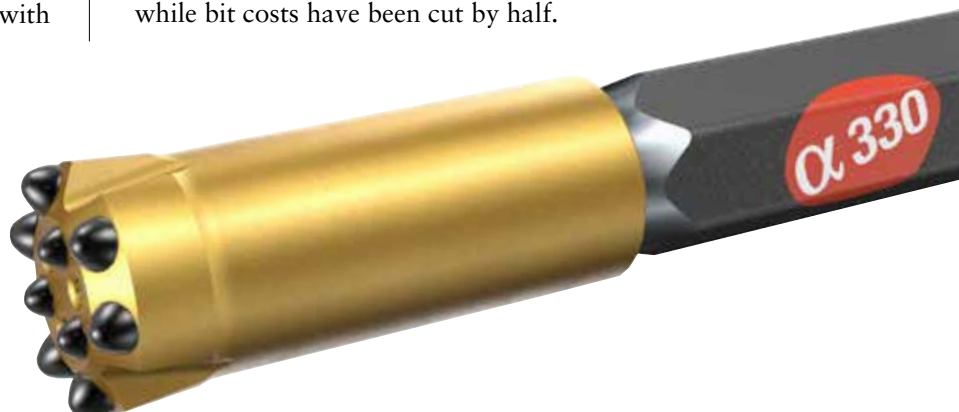

MAINTAIN PERFORMANCE WITH PROPER CARE AND ATTENTION



Cemented carbide is one of the most successful composite engineering materials produced. Its unique combination of strength, hardness and toughness satisfies the most demanding applications – but working with such high stresses, inserts and buttons are more subject to wear.



The height of the cemented carbide diminishes as wear progresses resulting in wear flats.



Wear to the cemented carbide on the periphery of the bit is abnormally high, causing an “anti-taper” to develop, which diminishes the clearance of the bit.



Here the surface became fatigued with microscopic cracks developing.

BUTTON BITS SHOULD BE REGROUND WHEN PENETRATION RATES DROP OR IF THE CEMENTED CARBIDE SHOWS SIGNS OF DAMAGE

Fixed grinding routines bring with them good working practice. Bits for instance, should be examined then reground after a specific number of holes, or at the end of the shift. Premature grinding is not necessarily uneconomical since less carbide needs to be ground off. It is better to regrind then experience low productivity due to damage.

Proper grinding adds considerably to drill bit service life. Another equally important fact of proper grinding is it also enhances the performance of the entire drilling operation, especially hole straightness.

Grinding should always be done in accordance with safety regulations, read more about our Health and Safety Information at page 99.

THREADS ARE SUBJECTED TO HIGH STRESS AND REQUIRE SPECIAL CARE

LUBRICATION

Thread grease reduces wear and helps in the uncoupling of rods.

Replace the lid on the grease container after use. The grease must be protected from drilling dust, left unprotected it will interact with the dust. Left to act as a grinding compound rather than lubricator next time it is used.

THREAD WEAR

Drilling with worn threads carries a great risk of equipment downtime.

When replacing the drill rods, it is often more economical to replace the coupling as well. Mixing new and old threads can make the newer threads wear more quickly.

BENT AND BLOCKED DRILL STEELS

Not all bent drill steels have to be discarded. They can often be straightened, either in the hole or with a straightening press.

Drill steels and rods flushing holes can become blocked. The blockage can usually be removed with the aid of a copper tube and water flushing.

TRANSPORTATION AND STORAGE

During transportation, bits and cemented components must be packed so as to prevent damage to the cemented carbide. Even though cemented carbide is very resistant to impact against other materials, it is easily damaged by collision with other cemented carbide components.

INCREASED PRODUCTION VS GOOD DRILLING PRACTICE

Good drilling practices and correct machines settings are important for the service life of your drilling tools. Good management and maintenance also play a crucial role in the end cost and schedule.





BIT DIAMETER NOTES

All bit diameters are larger than the given dimensions in the catalog

- Cross bits: Can be a maximum of +1mm due to manufacturing tolerance

- Button bits: Some bit designs can be a maximum +3mm to compensate for fast diameter wear.
 The minimum diameter for all button bits is +1.5mm above the given dimensions

Keep in mind that a bit always gives a bigger hole than the stated bit diameter.

BIT CLASSIFICATION CODES

- H:** Very hard to hard rock..... > 2500 bar (250 MPa)
- M:** Medium hard rock..... 1500-2500 bar (150-250 MPa)
- S:** Soft rock < 1500 bar (150 MPa)

-
- C:** Homogeneous (competent) rock
 - F:** Fissured rock

-
- V:** Very abrasive rock > 40% silica
 - A:** Abrasive rock 20-40% silica
 - N:** Non-abrasive rock 0-20% silica





INCREASE SERVICE LIFE AND EXTEND PRODUCTIVITY

Integral drill steels, tapered rods, drill bits and threaded rods are key to high productivity in all applications. Sandvik drill steel has high fatigue strength and toughness, offers high wear resistance giving an efficient and economic drilling operation. Our unique R23 rods and bits for extension drilling provide the strongest thread in hole sizes 33–45 mm. For Underground applications we have fully carburized rods with superior wear resistance and service life. In fact working with Sandvik means you can expect consistent high quality and maximum operational dependability when it comes to all small hole drilling applications.

H19 (3/4) INTEGRAL DRILL STEELS	18
H22 (7/8") INTEGRAL DRILL STEELS	19
REAMING TOOLS	20
H22 TAPERED TOOLS, 12° TAPER	21
H22 TAPERED TOOLS, 11° TAPER	23
H22 TAPERED TOOLS, 7° TAPER	24
STONE WORKING TOOLS	25
R22 (7/8") EXTENSION DRILLING TOOLS	26
R23 (29/32") EXTENSION DRILLING TOOLS	27
R25 (1") EXTENSION DRILLING TOOLS	38
SANDVIK ALPHA. α250 BIT THREAD	29



SMALL HOLE DRILLING

HI9 (3/4") Integral drill steels

HI9 (3/4")

	Dimensions D						Part No.
	Series	L mm	ft	in	D mm	in	
Shank 19 x 108 mm (3/4" x 4 1/4")							
	21	400	1'	4"	29	19/64"	724-0429
	-	800	2'	7"	28	1 7/64"	724-0828
	-	1600	5'	3"	27	1 1/16"	724-1627
	-	2400	7'	10"	26	1 1/32"	724-2426
	24	600	2'	-	27	1 1/16"	724-0627
-	1200	3'	11"	26	1 1/32"	724-1226	
Boulder-steel	400	1'	4"	24	15/16"	724-0424	
	800	2'	7"	23	29/32"	724-0823	

Shank 22 x 108 mm (7/8" x 4 1/4")							
		400	1'	4"	24	15/16"	728-0424
		400	1'	4"	29	1 9/64"	728-0429
		800	2'	7"	28	1 7/64"	728-0828
		1600	5'	3"	27	1 1/16"	728-1627

SMALL HOLE DRILLING

H22 (7/8") Integral drill steels

	Dimensions D						Part No.
	Series	L mm	ft	in	D mm	in	

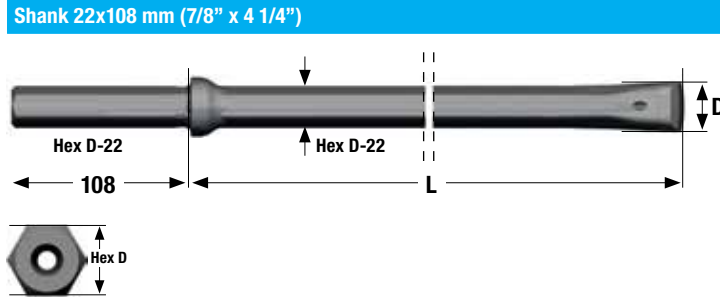

Shank 22x108 mm (7/8" x 4 1/4")							
11	800	2'	7"	34	1 11/32"	714-0834-65	
	1600	5'	3"	33	1 19/64"	714-1633-65	
	2400	7'	10"	32	1 1/4"	714-2432-65	
	3200	10'	6"	31	1 7/32"	714-3231	
	4000	13'	1"	30	1 3/16"	714-4030	
	4800	15'	9"	29	1 9/64"	714-4829	
	5600	18'	4"	28	1 7/64"	714-5628-50	
	6400	21'	–	27	1 1/16"	714-6427-50	
	7200	23'	8"	26	1 1/32"	714-7226-50	
12	800	2'	7"	40	1 37/64"	714-0840-65	
	1600	5'	3"	39	1 17/32"	714-1639-65	
	2400	7'	10"	38	1 1/2"	714-2438-65	
	3200	10'	6"	37	1 29/64"	714-3237-65	
	4000	13'	1"	36	1 27/64"	714-4036-65	
	4800	15'	9"	35	1 3/8"	714-4835-65	
	5600	18'	4"	34	1 11/32"	714-5634-65	
	6400	21'	–	33	1 19/64"	714-6433-65	
	7200	23'	8"	32	1 1/4"	714-7232-65	
13	400	1'	4"	34	1 11/32"	714-0434-65	
	800	2'	7"	33	1 19/64"	714-0833-65	
	1200	3'	11"	32	1 1/4"	714-1232-65	
	1600	5'	3"	31	1 7/32"	714-1631	
	2000	6'	7"	30	1 3/16"	714-2030	
16	600	2'	–	35	1 3/8"	714-0635-65	
	1200	3'	11"	34	1 11/32"	714-1234-65	
	1800	5'	11"	33	1 19/64"	714-1833-65	
	2400	7'	10"	32	1 1/4"	714-2432-65	
17	600	2'	–	41	1 5/8"	714-0641-65	
	1200	3'	11"	40	1 37/64"	714-1240-65	
	1800	5'	11"	39	1 17/32"	714-1839-65	
	2400	7'	10"	38	1 1/2"	714-2438-65	
	2000	6'	7"	33	1 19/64"	714-2033-65	
	8000	26'	3"	26	1 1/32"	714-8026-50	
	8800	28'	11"	25	1"	714-8825-5005	
	9600	31'	6"	25	1"	714-9625-5005	
	800	2'	7"	29	1 9/64"	714-0829	
	1600	5'	3"	28	1 7/64"	714-1628-50	
	2400	7'	10"	27	1 1/16"	714-2427-50	

SMALL HOLE DRILLING

H22 Reaming tools

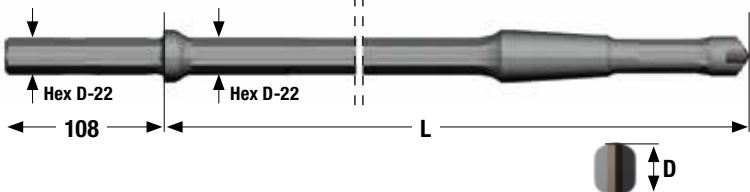
		Dimensions D					Part No.
		L			D		
		mm	ft	in	mm	in	
Pilot rod, Hex 22, 6° taper							
		800	2'	7 1/2"	26	1 1/32"	7922-6108-11
		1200	3'	11 3/4"	26	1 1/32"	7922-6112-11
		2000	6'	6 3/4"	26	1 1/32"	7922-6120-11
		2400	8'	2 1/2"	26	1 1/32"	7922-6124-11

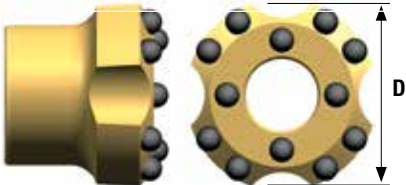
	Buttons, mm		Angle	Dimensions D		Part No.
	Front No	Size		Gauge No	Size	
Reaming tools for cut holes / Reaming bit, 6° taper						
	4x8	8x9	25°	64	2 1/2"	7722-4864-S48
	4x10	8x10	30°	76	3"	7722-4876-S48
	6x10	8x10	30°	89	3 1/2"	7722-4889-S48

SMALL HOLE DRILLING

H22 Tapered tools, 12° taper

Bits	Flushing hole, mm		Buttons, mm		Angle	Dimensions D		Part No.
	Front No Size	Gauge No Size	Front No Size	Gauge No Size		mm	in	
Button bit								
	1x5	1x5	1x7	4x7	35°	28	1 1/8"	7795-6428-B48
	1x5	1x5	1x7	4x7	35°	30	1 3/16"	7795-6430-B48
Button bit								
	2x4	1x4	2x7	5x7	40°	32	1 1/4"	7795-5232-B48
	2x4	1x4	2x7	5x8	40°	35	1 3/8"	7795-5235-B48
	2x4	1x4	2x7	5x9	40°	38	1 1/2"	7795-5238-B48
Button bit								
	2x4	1x4	2x7	5x7	40°	33	1 9/64"	7770-5233-B48
	2x4	1x4	2x7	5x8	35°	35	1 3/8"	7770-5235-B48
Button bit								
	1x4	1x6	2x7	5x7	35°	33	1 9/64"	7770-4433-B48
	1x5	1x5	2x7	5x7	35°	35	1 3/8"	7770-4435-B48
Button bit								
	2x4	1x4	6x7	2x7	40°	33	1 9/64"	7770-5433-B48
Cross bit								
	1x4	2x4	–	–	–	30	1 3/16"	7770-9030-42
	1x6	2x4.5	–	–	–	32	1 1/4"	7770-9032-42
	1x6	2x4.5	–	–	–	35	1 3/8"	7770-9035-42

SMALL HOLE DRILLING

H22 Tapered tools, 12° taper

H22 - 12°

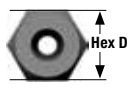
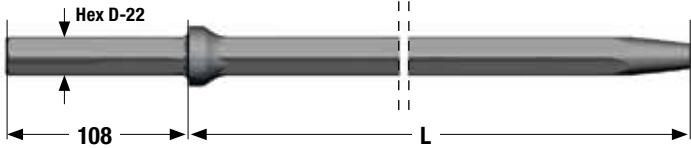
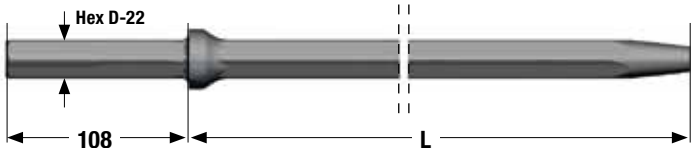
Rods		Dimensions D					Part No.
		L			Hex D		
		mm	ft	in	mm	in	
Tapered rod, shank 22x108, carburized							
		610	2'	–	22	7/8"	7870-6106-11
		1220	4'	–	22	7/8"	7870-6112-11
		1830	6'	–	22	7/8"	7870-6118-11
		2000	6'	7"	22	7/8"	7870-6120-11
		2440	8'	–	22	7/8"	7870-6124-11
		3050	10'	–	22	7/8"	7870-6131-11
		3200	10'	6"	22	7/8"	7870-6132-11
		3660	12'	–	22	7/8"	7870-6137-11
Tapered rod, shank 22x108, HF-hardened - For surface drilling							
		2440	8'	–	22	7/8"	7870-5124-11
		3200	10'	6"	22	7/8"	7870-5132-11
		4000	13'	1 1/2"	22	7/8"	7870-1140-11
		4400	14'	5"	22	7/8"	7870-1144-11
		4800	15'	9"	22	7/8"	7870-1148-11
		5600	18'	4 1/2"	22	7/8"	7870-1156-11
		6400	21'	–	22	7/8"	7870-1164-11
		7200	23'	7 1/2"	22	7/8"	7870-1172-11
	8000	26'	3"	22	7/8"	7870-1180-11	
	8800	28'	10 1/2"	22	7/8"	7870-1188-11	

SMALL HOLE DRILLING

H22 Tapered tools, 11° taper

Bits	Flushing hole, mm		Buttons, mm		Angle	Dimensions D		Part No.
	Front No Size	Gauge No Size	Front No Size	Gauge No Size		mm	in	
Button bit								
	1x6	1x6	2x8	3x9	40°	38	1 1/2"	7776-1938-B48
	1x6	1x6	2x8	3x9	40°	40	1 37/64"	7776-1940-B48

Button bit								
	1x5	1x5	2x7	5x7	40°	32	1 1/4"	7776-4432-B48
	1x5	1x5	2x7	5x8	40°	35	1 3/8"	7776-4435-B48
	1x5	1x5	2x7	5x8	35°	36	1 7/16"	7776-4436-B48
	1x5	1x5	2x7	5x8	35°	38	1 1/2"	7776-4438-B48
	1x6	1x6	2x8	5x9	35°	40	1 37/64"	7776-4440-B48

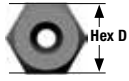
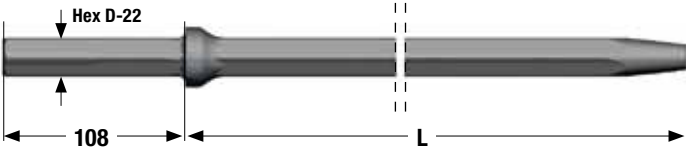
Rods		Dimensions D					Part No.
		L			Hex D		
Tapered rod, shank 22x108, carburized		mm	ft	in	mm	in	
	610	2'	–	22	7/8"	7876-6106-11	
	800	2'	7 1/2"	22	7/8"	7876-6108-11	
	1220	4'	–	22	7/8"	7876-6112-11	
	1600	5'	3"	22	7/8"	7876-6116-11	
	1830	6'	–	22	7/8"	7876-6118-11	
	2000	6'	7"	22	7/8"	7876-6120-11	
	2440	8'	–	22	7/8"	7876-6124-11	
	3050	10'	–	22	7/8"	7876-6131-11	
	3600	11'	9 1/2"	22	7/8"	7876-6136-11	

SMALL HOLE DRILLING

H22 Tapered tools, 7° taper

H22-7°

Bits	Flushing hole, mm		Buttons, mm		Angle	Dimensions D		Part No.
	Front No Size	Gauge No Size	Front No Size	Gauge No Size		mm	in	
Button bit								
	2x5	1x5	2x7	5x7	40°	32	1 1/4"	7788-5232-B48
	2x4	1x4	2x7	5x7	40°	33	1 9/64"	7788-5233-B48
	2x4	1x4	2x7	5x8	40°	35	1 3/8"	7788-5235-B48
	2x4	1x4	2x7	5x8	35°	38	1 1/2"	7788-5238-B48

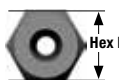
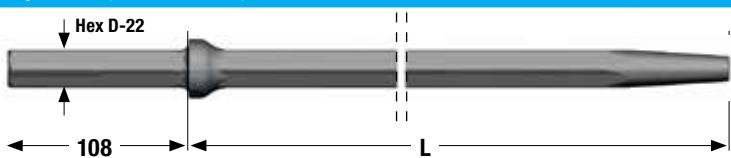
Rods		Dimensions D				Part No.
		L			Hex D	
Tapered rod, shank 22x108, carburized						
	2400	8'	–	22	7/8"	7888-6124-11
	3200	10'	6"	22	7/8"	7888-6132-11

SMALL HOLE DRILLING

Stone working tools

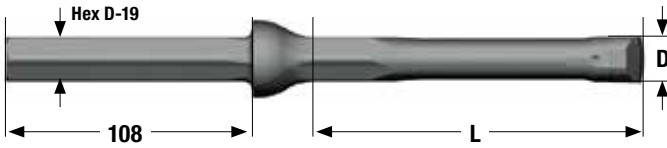
	Dimensions D					Part No.
	L mm	ft	in	D mm	in	
Plug hole integral steel						
	150		6"	17	21/32"	721-1517
	160		6 1/4"	20	25/32"	721-1620
	200		7 7/8"	20	25/32"	721-2020
	240		9 29/64"	20	25/32"	721-2420
	280		11 1/32"	20	25/32"	721-2820
	310		11 1/4"	20	25/32"	721-3120
	160		6 1/4"	22	7/8"	721-1622
	190		7 1/2"	22	7/8"	721-1922

SMALL HOLE DRILLING

R22 (7/8") Extension drilling tools

R22 (7/8")

Cross bit	Flushing hole, mm		Buttons, mm		Angle	Dimensions D		Part No.
	Front No Size	Gauge No Size	Front No Size	Gauge No Size		mm	in	

Cross bit



1	4.5	2	4.5	–	38	1 1/2"	7731-1038-42
---	-----	---	-----	---	----	--------	--------------

Extension rod R22 - Hex 22 - R22	Hex D	Dimensions D					Part No.
		L mm	ft	in	D mm	in	

Extension rod R22 - Hex 22 - R22

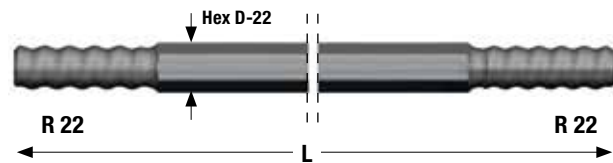

800	2'	7"	22	7/8"	7851-1308-20
1200	3'	11"	22	7/8"	7851-1312-20
1600	5'	3"	22	7/8"	7851-1316-20

Shank adapter/Shank rod, Hex 22 - R22

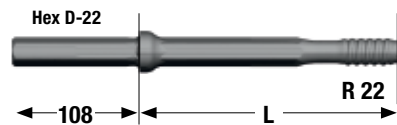

255	–	10 3/64"	22	7/8"	7801-6103-11
-----	---	----------	----	------	--------------

Coupling sleeve, R22



140	–	5 1/2"	31	1 7/32"	7991-2031
-----	---	--------	----	---------	-----------

SMALL HOLE DRILLING

R23 (29/32") Extension drilling tools

Bits	Flushing hole, mm		Buttons, mm		Angle	Dimensions D		Bit Classification	Part No.
	Front No Size	Gauge No Size	Front No Size	Gauge No Size		mm	in		
Button bit									
	1x4	1x6	2x7	5x7	35°	33	1 5/16"	HMCA	7737-4433-R48
	1x6	1x6	2x7	5x8	40°	35	1 3/8"	HMCA	7737-5235-R48
	1x6	1x6	2x7	5x8	35°	38	1 1/2"	HMCA	7737-5238A-R48
	1x6	1x6	2x8	5x9	35°	41	1 5/8"	HMCA	7737-5241-R48

Button bit									
	3x5	–	3x8	6x9	30°	45	1 3/4"	HMCA	7737-5345-R48

Rods	Dimensions D					Part No.
	L			Hex D		
	mm	ft	in	mm	in	

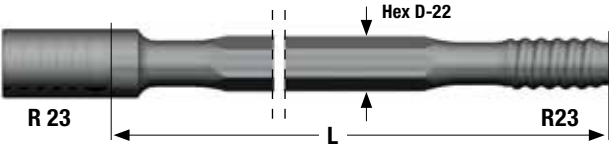
MF-rod, R23 - Hex 22 - R23						
	2095	6'	10 1/2"	22	7/8"	7857-4821-20
	3050	10'	–	22	7/8"	7857-4831-20

Female end Ø 31 mm



Shank adapter / Shank rod, Hex 22 - R23						
	255	–	10 3/64"	22	7/8"	7807-6103-11
	800	2'	7"	22	7/8"	7807-6108-11
	1600	5'	3"	22	7/8"	7807-6116-11
	2400	8'	–	22	7/8"	7807-6124-11
	3200	10'	–	22	7/8"	7807-6132-11
	3600	11'	9 5/8"	22	7/8"	7807-6136-11

Shank adapter / Shankrod Hex 25 - R 23						
	255	–	10 3/64"	25	1"	7807-7103-30
	3600	11'	9"	25	1"	7807-7136-30

SMALL HOLE DRILLING

R25 (1") Extension drilling tools

R25 (1")

Bits	Flushing hole, mm		Buttons, mm		Angle	Dimensions D		Bit Classification	Part No.
	Front No Size	Gauge No Size	Front No Size	Gauge No Size		mm	in		
Button bit									
	1x4	1x6	2x7	5x8	35°	35	1 3/8"	HMCA	7732-4435-S48 
	1x5	1x6	2x7	5x8	40°	35	1 3/8"	HMCA	7732-5235-R48
	1x6	1x6	2x7	5x9	30°	38	1 1/2"	HMCA	7732-5238-S48
	1x6	1x6	2x7	5x9	35°	38	1 1/2"	HMCA	7732-5238-R48
	1x6	1x6	2x8	5x9	35°	41	1 5/8"	HMCA	7732-5241-S48
	1x6	1x6	2x8	5x9	35°	41	2 5/8"	HMCA	7732-5241-R48

Button bit									
	3x4.5	–	3x8	6x9	40°	45	1 3/4"	MSCFAN	7732-5345F-R48

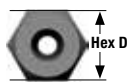
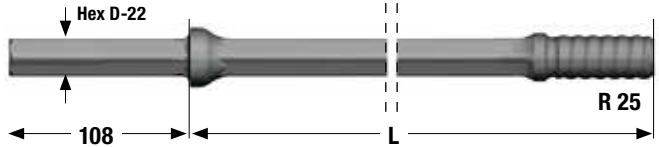
Rods		Dimensions D					Part No.
		L mm	ft	in	Hex D mm	in	
Shank adapter / rod, Hex 22 x R25							
	255	–	10 3/64"	22	7/8"	7802-6103-11	
	800	2'	7"	22	7/8"	7802-6108-11	
	1000	3'	3"	22	7/8"	7802-6110-11	

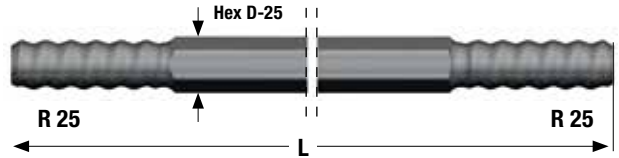
Extension rod, R25 - Hex 25 - R25						
	915	3'	–	25	1"	7852-2309-20
	1220	4'	–	25	1"	7852-2312-20
	1525	5'	–	25	1"	7852-2315-20
	1830	6'	–	25	1"	7852-2318-20
	2435	8'	–	25	1"	7852-2324-20
	3050	10'	–	25	1"	7852-2331-20

Coupling sleeve, R25						
	160	–	6 1/4"	35	1 3/8"	7992-2035

 – For one-rod drilling

SMALL HOLE DRILLING

Sandvik Alpha. α 250 bit thread

α 250

Bits	Flushing hole, mm		Buttons, mm		Angle	Dimensions D		Bit Classification	Part No.
	Front No Size	Gauge No Size	Front No Size	Gauge No Size		mm	in		

Button bit									
	1x6	1x6	2x7	5x9	35°	38	1 1/2"	HMCA	7764-5238-R48

Button bit									
	3x4.5	–	3x8	6x9	40°	45	1 3/4"	MSCFAN	7764-5345F-R48

Rods		Dimensions D					Part No.
		L			Hex D		
		mm	ft	in	mm	in	

Shank rod, Hex 25 - α 250							
	3600	11'	9 5/8"	25	1"	7814-7136-30	



.....

PRECISION ENGINEERING FOR STRAIGHTER DRILL HOLES

- Short thread design with sturdy guides, well inside the bit skirt offers higher precision in collaring – even in complex rock formations and uneven surfaces.
- Rigid drill string results in straighter holes, permitting optimum drilling patterns and higher rate of advance.
- Exact collaring and straighter holes are prerequisites for productive drilling with less over break and lower overall costs.
- Hexagonal rods in the tool system result in a rigid, integrated power pack drill string results in superior resistance to bending stresses and gives improved bit guidance as well as perfect energy transfer.
- More efficient energy transmission with minimal wear on all components in the drilling system.
- Short thread and robust guide improves service life on drifter rods with at least +30% compared to R32 rods.

NEW DESIGN PROVIDES TROUBLE FREE OPERATION

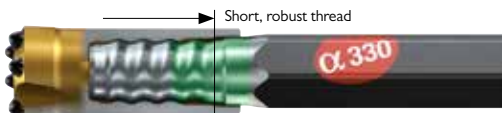

Sandvik Alpha 330

- Reduced bending stresses
- Easy uncoupling

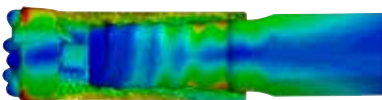

Advanced analysis have been used to simulate and locate critical bending stresses of various designs to arrive at an optimally dimensioned rod / bit connection.



.....

SANDVIK ALPHA ROD/BIT CONNECTIONS TAKE DRILLING PRODUCTIVITY TO A NEW LEVEL

Sandvik engineers are constantly engaged in upgrading our tool systems. Supported by our in-house manufacturing facilities, the results of their work speaks for themselves, providing new profitable solutions for all rock drilling professionals.

R25 (1") BIT THREAD	32
R28 (1 1/8") BIT THREAD	34
R32 (1 1/4") BIT THREAD	35
SANDVIK ALPHA. α330 BIT THREAD	38
R35 (1 3/8") BIT THREAD	41
SANDVIK EXTRA. R35 (1 3/8") BIT THREAD	43
SANDVIK BITS	44



DRIFTING AND TUNNELING

R25 (1") bit thread

R25 (1")

Bits	Flushing hole, mm		Buttons, mm		Angle	Dimensions D		Bit Classification	Part No.
	Front No Size	Gauge No Size	Front No Size	Gauge No Size		mm	in		

Button bit, type 52

	1x4,5	1x6	2x7	5x7	45°	33	1 5/16"	HMCA	7732-4433C-S48
	1x5	1x6	2x7	5x9	30°	35	1 3/8"	HMCA	7732-4435-S48
	1x5	1x6	2x7	5x9	30°	37	7/16"	HMCA	7732-4437C-S48
	1x6	1x6	2x7	5x9	30°	38	1 1/2"	HMCA	7732-5238-S48
	1x6	1x6	2x7	5x9	35°	38	1 1/2"	MCAN	7732-5238-R48
	1x6	1x6	2x8	5x9	35°	41	1 5/8"	HMCA	7732-5241-S48

Cross bit

	1x5	2x5				35	1 3/8"	-	7732-1435-42
--	-----	-----	--	--	--	----	--------	---	--------------

Rods		Dimensions D					Part No.
		L mm	ft	in	D mm	in	

Drifter rod, R32 - Hex 25 - R25

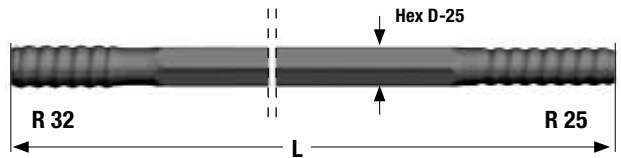
 <p>Flushing hole \varnothing 8,6 mm</p>	1870	6'	1 5/8"	25	1"	7853-2418-20
	2175	7'	1 5/8"	25	1"	7853-2421-20
	2475	8'	1 1/2"	25	1"	7853-2424-20
	2630	8'	7 1/2"	25	1"	7853-2426-20
	2785	9'	1 5/8"	25	1"	7853-2427-20
	2935	9'	7 1/2"	25	1"	7853-2429-20
	3090	10'	1 5/8"	25	1"	7853-2431-20
	3340	10'	11 1/2"	25'	1"	7853-2433-20
	3700	12'	1 5/8"	25'	1"	7853-2437-20

Coupling sleeve, R32

	150		5 29/32"	44	1 47/64"	7993-3644
--	-----	--	----------	----	----------	-----------

DRIFTING AND TUNNELING

R25 (1") reaming tools

	Thread	Dimensions D					Part No.
		L mm	ft	in	D mm	in	
Reaming tools for cut holes / Pilot adapter, 6° taper							
	R25	-	-	-	26	1 1/32"	7822-2526



	Buttons, mm		Angle	Dimensions D		Part No.
	Front No Size	Gauge No Size		mm	in	
Reaming tools for cut holes / Reaming bit, 6° taper						

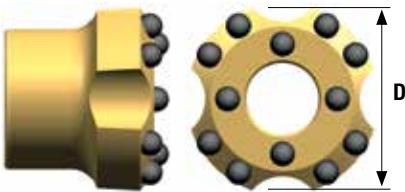

4x8	8x9	25°	64	2 1/2"	7722-4864-S48
4x10	8x10	30°	76	3"	7722-4876-S48
6x10	8x12	35°	89	3 1/2"	7722-4889-S48

R25 (1")

DRIFTING AND TUNNELING

R28 (1 1/8") bit thread

R28 (1 1/8")

Bits	Flushing hole, mm		Buttons, mm		Angle	Dimensions D		Bit Classification	Part No.
	Front No Size	Gauge No Size	Front No Size	Gauge No Size		mm	in		

Button bit, type 52									
	1x5	1x6	2x7	5x9	30°	37	7/16"	HMCA	7739-5237-S48
	1x6	1x6	2x7	5x9	35°	38	1 1/2"	MCAN	7739-5238-R48
	1x6	1x6	2x7	5x9	30°	38	1 1/2"	HMCA	7739-5238-S48
	1x6	1x6	2x8	5x9	35°	41	1 5/8"	HMCA	7739-5241-S48
	1x6	1x6	2x8	5x10	30°	43	1 11/16"	HMCA	7739-5243-S48

Cross bit									
	1x5	2x5	-	-		38	1 1/2"		7739-1438-42

Reaming tools	Thread	Dimensions D					Part No.
		L mm	ft	in	D mm	in	

Reaming tools for cut holes / Pilot adapter, 6° taper							
	R28	-	-	-	26	1 1/32"	7822-1526

Reaming tools for cut holes / Reaming bit, 6° taper	Buttons, mm		Angle	Dimensions D		Part No.
	Front No Size	Gauge No Size		mm	in	

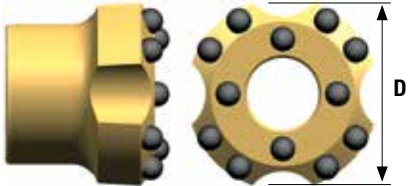
	4x8	8x9	25°	64	2 1/2"	7722-4864-S48
	4x10	8x10	30°	76	3"	7722-4876-S48
	6x10	8x12	35°	89	3 1/2"	7722-4889-S48

Rods		Dimensions D					Part No.
		L mm	ft	in	D mm	in	

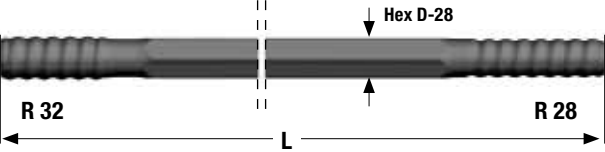
Drifter rod, R32 - Hex 28 - R28						
	2475	8'	1 1/2"	28	1 1/8"	7853-7624-20
	2785	9'	1 5/8"	28	1 1/8"	7853-7627-20
	3090	10'	1 5/8"	28	1 1/8"	7853-7631-20
	3700	12'	1 5/8"	28	1 1/8"	7853-7637-20
	4305	14'	1 1/2"	28	1 1/8"	7853-7643-20

Flushing hole Ø 8,8 mm

Coupling sleeve, R32						
	150		5 29/32"	44	1 47/64"	7993-3644

DRIFTING AND TUNNELING

R32 (1 1/4") bit thread

Bits	Flushing hole, mm		Buttons, mm		Angle	Dimensions D		Bit Classification	Part No.
	Front No Size	Gauge No Size	Front No Size	Gauge No Size		mm	in		
Button bit, type 52									
	1x5	2x6	2x9	5x10	35°	43	1 11/16"	HMCVA	7733-5243A-S48
	1x5	2x6	2x9	5x11	30°	45	1 3/4"	HMCVA	7733-5245A-S48
	1x6	2x7.5	2x9	5x11	35°	48	1 7/8"	HMCVA	7733-5248A-S48
	1x6	2x7.5	2x10	5x12	35°	51	2"	HMCVA	7733-5251A-S48
Button bit, type 54									
	2x6	2x6	2x9	6x9	40°	43	1 11/16"	MSCAN	7733-5443B-R48
	2x6	2x6	2x9	6x10	35°	45	1 3/4"	MSCAN	7733-5445B-R48
Button bit, type 53/16									
	3x4.5	1x4.5	3x8	6x9	30°	43	1 11/16"	MSCAN	7733-5343A-R48
	3x4.5	1x5	3x8	6x10	25°	45	1 3/4"	HMCAN	7733-5345A-S48
	3x4.5	1x5	3x8	6x10	30°	45	1 3/4"	MSCAN	7733-5345A-R48
	3x5	1x5	3x9	6x10	30°	48	1 7/8"	HMCAN	7733-5348A-S48
	3x5	1x5	3x9	6x10	30°	48	1 7/8"	HMCAN	7733-5348A-R48
	3x6	1x6	3x9	6x10	35°	51	2"	MSCAN	7733-1651A-S48
	3x6	1x6	3x9	6x10	40°	51	2"	MSCAN	7733-1651A-R48
	3x6	1x6	3x10	6x11	35°	57	2 1/4"	HMCA	7733-1657A-S48
	3x7	-	3x11	6x12	30°	64	2 1/2"	HMCVA	7733-1664-S48
Button bit, type 55									
	3x5.5	3x5.5	3x9	3x9	40°	45	1 3/4"	SCFN	7733-5545A-C60
	3x6	1x6	3x9	6x10	40°	51	2"	SCFN	7733-5551A-C60
Button bit, type 18									
	4x7	-	5x11	8x12	35°	76	3"	HMCVA	7733-1876-S48
Cross bit									
	1x5	4x6	-	-	-	45	1 3/4"		7733-1345A-42

DRIFTING AND TUNNELING

R32 (1 1/4") bit thread

R32 (1 1/4")

Rods	Dimensions D					Part No.
	L mm	ft	in	D mm	in	

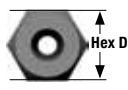

Drifter rod, R38 - Hex 35 - R32						
	3090	10'	1 5/8"	35	1 3/8"	7854-9631-20
	3700	12'	1 5/8"	35	1 3/8"	7854-9637-20
	4305	14'	1 1/2"	35	1 3/8"	7854-9643-20
	4915	16'	1 1/2"	35	1 3/8"	7854-9649-20
	5525	18'	1 1/2"	35	1 3/8"	7854-9655-20

Drifter rod, R38 - Hex 32 - R32						
---------------------------------	--	--	--	--	--	--

	3090	10'	1 5/8"	32	1 1/4"	7854-8631-20
	3700	12'	1 5/8"	32	1 1/4"	7854-8637-20
	4305	14'	1 1/2"	32	1 1/4"	7854-8643-20
	4915	16'	1 1/2"	32	1 1/4"	7854-8649-20

Drifter rod, T38 - Hex 32 - R32						
---------------------------------	--	--	--	--	--	--

	3700	12'	1 5/8"	32	1 1/4"	7324-8637-20
	4305	14'	1 1/2"	32	1 1/4"	7324-8643-20

Drifter rod, T38 - Hex 35 - R32						
---------------------------------	--	--	--	--	--	--

	3090	10'	1 5/8"	35	1 3/8"	7324-9631-20
	3700	12'	1 5/8"	35	1 3/8"	7324-9637-20
	4305	14'	1 1/2"	35	1 3/8"	7324-9643-20
	4915	16'	1 1/2"	35	1 3/8"	7324-9649-20
	5525	18'	1 1/2"	35	1 3/8"	7324-9655-20
	6135	20'	1 1/2"	35	1 3/8"	7324-9661-20
	6440	21'	1 1/2"	35	1 3/8"	7324-9664-20

MF Drifter rod, T38 - Hex 35 - R32						
------------------------------------	--	--	--	--	--	--

	3700	12'	1 1/2"	35	1 3/8"	7324-6537-20
	4305	14'	1 1/2"	35	1 3/8"	7324-6543-20

Coupling sleeve						
-----------------	--	--	--	--	--	--

	R38	170	-	6 3/4"	55	2 5/32"	7994-3655
	T38	191	-	7 1/2"	52	2"	7314-3652

DRIFTING AND TUNNELING

R32 (1 1/4") reaming tools

R32 (1 1/4")

Pilot adapters 6°, 12° taper	Thread	Dimensions D					Part No.
		L mm	ft	in	D mm	in	

Reaming tools for cut holes / Pilot adapter, 6° taper

	R32	-	-	-	26	1 1/32"	7822-3526
---	-----	---	---	---	----	---------	-----------

Reaming tools for cut holes / Pilot adapter, 12° taper

	R32	-	-	-	40	1 37/64"	7821-3440
---	-----	---	---	---	----	----------	-----------

Reaming bit 6°, 12° taper	Buttons, mm		Angle	Dimensions D		Part No.
	Front No Size	Gauge No Size		mm	in	

Reaming tools for cut holes / Reaming bit, 6° taper

	4x8	8x9	25°	64	2 1/2"	7722-4864-S48
	4x10	8x10	30°	76	3"	7722-4876-S48
	6x10	8x12	35°	89	3 1/2"	7722-4889-S48

Reaming tools for cut holes / Reaming bit, 12° taper

	4x10	8x12	35°	89	3 1/2"	7721-4889-S48
	4x13	8x13	35°	102	4"	7721-4802-S48
	8x13	8x13	35°	127	5"	7721-4827-S48

Reaming bit	Flushing hole, mm		Buttons, mm		Angle	Dimensions D		Part No.
	Front No Size	Gauge No Size	Pilot No Size	Gauge No Size		mm	in	

Reaming tools for cut holes / Reaming bit, R32

	4x6	-	3x10	12x13	35°	102	4"	7733-5602P-S48
---	-----	---	------	-------	-----	-----	----	----------------

DRIFTING AND TUNNELING

Sandvik Alpha. α 330 bit thread

Bits	Flushing hole, mm		Buttons, mm		Angle	Dimensions D		Bit Classification	Part No.
	Front No Size	Gauge No Size	Front No Size	Gauge No Size		mm	in		
Button bit, type 52									
	1x5	1x7.5	2x9	6x10	35°	43	1 11/16"	HMCVA	7767-5243A-S48
	1x5	1x7.5	2x9	5x11	30°	45	1 3/4"	HMCVA	7767-5245A-S48
	1x6	2x7.5	2x9	5x11	35°	48	1 7/8"	HMCVA	7767-5248A-S48
Button bit, type 54									
	2x6	2x6	2x9	6x9	40°	43	1 11/16"	MSCAN	7767-5443B-R48
	2x6	2x6	2x9	6x10	35°	45	1 3/4"	MSCAN	7767-5445B-R48
Button bit, type 53/16									
	3x4.5	1x4.5	3x8	6x9	30°	43	1 11/16"	MSCAN	7767-5343A-R48
	3x4.5	1x5	3x8	6x10	30°	45	1 3/4"	MSCAN	7767-5345A-R48
	3x4.5	1x5	3x8	6x10	25°	45	1 3/4"	HMCAN	7767-5345A-S48
	3x5	1x5	3x9	6x10	30°	48	1 7/8"	MSCAN	7767-5348A-R48
	3x5	1x5	3x9	6x10	30°	48	1 7/8"	HMCAN	7767-5348A-S48
	3x6	1x6	3x9	6x10	40°	51	2"	MSCAN	7767-1651A-R48
	3x6	1x6	3x9	6x10	35°	51	2"	HMCAN	7767-1651A-S48
	3x7	-	3x11	6x12	30°	64	2 1/2"	HMCAN	7767-1664-S48
Button bit, type 18									
	4x7	-	5x10	8x11	35°	76	3"	HMCAN	7767-1876-S48
Button bit, Retrac									
	3x6	-	3x9	6x10	35°	51	2"	HMCAN	7767-4651A-S48
Cross bit									
	1x5	4x6				45	1 3/4"		7767-1345A-42

DRIFTING AND TUNNELING

Sandvik Alpha. α 330 bit thread

Rods	Dimensions D					Part No.
	L mm	ft	in	D mm	in	

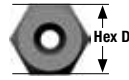

Drifter rod, T38 - Hex 35 - α 330						
	3090	10'	1 5/8"	35	1 3/8"	7324-6731-20
	3700	12'	1 5/8"	35	1 3/8"	7324-6737-20
	4305	14'	1 1/2"	35	1 3/8"	7324-6743-20
	4915	16'	1 1/2"	35	1 3/8"	7324-6749-20
	5525	18'	1 1/2"	35	1 3/8"	7324-6755-20

Drifter rod, T38 - Round 39 - α 330						
	4915	16'	1 1/2"	39	1 1/2"	7324-7049-20
	5525	18'	1 1/2"	39	1 1/2"	7324-7055-20
	6135	20'	1 1/2"	39	1 1/2"	7324-7061-20
	6440	21'	1 1/2"	39	1 1/2"	7324-7064-20

Flushing hole \varnothing 10,3 mm

alpha330

DRIFTING AND TUNNELING

Sandvik Alpha. α 330 bit thread

Coupling Sleeves	Dimensions D					Part No.
	L mm	ft	in	D mm	in	
Coupling sleeve, T38	191	-	7 1/2"	52	2"	7314-3652

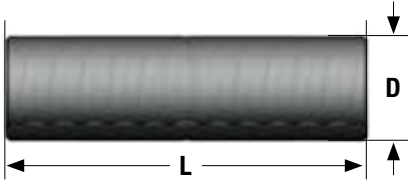

Reaming bit	Flushing hole, mm		Buttons, mm		Angle	Dimensions D		Part No.
	Front No Size	Gauge No Size	Pilot No Size	Gauge No Size		mm	in	
Reaming tools for cut holes / Reaming bit, α 330	2x6	2x6	3x10	12x13	35°	102	4"	7767-5602P-S48



Pilot adapter 12° taper	Thread	Dimensions D				Part No.	
		L mm	ft	in	D mm		in
Reaming tools for cut holes / Pilot adapter, 12° taper	α 330	-	-	-	40	1 37/64"	7821-6740



Reaming bit 12° taper	Buttons, mm		Angle	Dimensions D		Part No.
	Front No Size	Gauge No Size		mm	in	
Reaming tools for cut holes / Reaming bit, 12° taper	4x10	8x12	35°	89	3 1/2"	7721-4889-S48
	4x13	8x13	35°	102	4"	7721-4802-S48
	8x13	8x13	35°	127	5"	7721-4827-S48

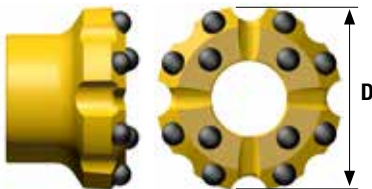



DRIFTING AND TUNNELING

R35 (1 3/8") bit thread

Bits	Flushing hole, mm		Buttons, mm		Angle	Dimensions D		Bit Classification	Part No.
	Front No Size	Gauge No Size	Front No Size	Gauge No Size		mm	in		

Button bit, type 53/16									
	3x5	1x5	3x9	6x10	30°	48	1 7/8"	HMCAN	7738-5348A-S48
	3x5	1x5	3x9	6x10	30°	48	1 7/8"	MSCAN	7738-5348A-R48

	3x6	1x6	3x9	6x10	35°	51	2"	HMCAN	7738-1651A-S48
	3x6	1x6	3x9	6x10	40°	51	2"	MSCAN	7738-1651A-R48

Cross bit									
	1x5	2x7.5	-	-	-	48	1 7/8"	-	7738-1448-42

Rods	Dimensions D					Part No.
	L mm	ft	in	D mm	in	

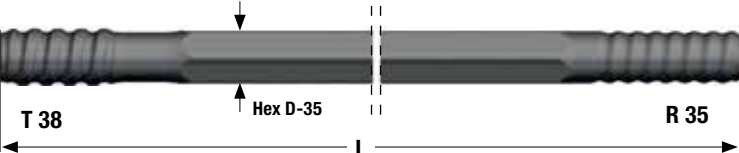
Drifter rod, T38 - Hex 35 - R35						
	4305	14'	1 1/2"	35	1 3/8"	7324-8543-20
	4915	16'	1 1/2"	35	1 3/8"	7324-8549-20
	5525	18'	1 1/2"	35	1 3/8"	7324-8555-20

Flushing hole \varnothing 9,5 mm

Drifter rod, T38 - Round 39 - R35						
	4305	14'	1 1/2"	39	1 1/2"	7324-7243-20
	4915	16'	1 1/2"	39	1 1/2"	7324-7249-20
	5525	18'	1 1/2"	39	1 1/2"	7324-7255-20
	6135	20'	1 1/2"	39	1 1/2"	7324-7261-20

Flushing hole \varnothing 14,5 mm

Drifter rod, T38 - Round 39 - R35						
	191	-	7 1/2"	52	2"	7314-3652

DRIFTING AND TUNNELING

R35 (1 3/8") bit thread

R35 (1 3/8")

Reaming bit	Flushing hole, mm		Buttons, mm		Angle	Dimensions D		Part No.
	Front No Size	Gauge No Size	Pilot No Size	Gauge No Size		mm	in	

Reaming tools for cut holes / Reaming bit, R35



2x6	2x6	3x10	12x13	35°	102	4"	7738-5602P-S48
-----	-----	------	-------	-----	-----	----	----------------

Pilot adapter 12° taper	Thread	Dimensions D					Part No.
		L mm	ft	in	D mm	in	

Reaming tools for cut holes / Pilot adapter, 12° taper



R35	-	-	-	-	40	1 37/64"	7821-5440
-----	---	---	---	---	----	----------	-----------

Reaming bit 12° taper	Buttons, mm		Angle	Dimensions D		Part No.
	Front No Size	Gauge No Size		mm	in	

Reaming tools for cut holes / Reaming bit, 12° taper

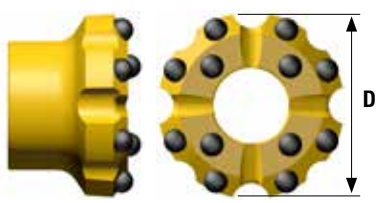

4x10	8x12	35°	89	3 1/2"	7721-4889-S48
4x13	8x13	35°	102	4"	7721-4802-S48
8x13	8x13	35°	127	5"	7721-4827-S48

DRIFTING AND TUNNELING

Sandvik Extra. R35 (I 3/8") bit thread

Bits	Flushing hole, mm		Buttons, mm		Angle	Dimensions D		Bit Classification	Part No.
	Front No Size	Gauge No Size	Front No Size	Gauge No Size		mm	in		

Button bit, Retrac R35									
	3x6	1x5	3x9	3x10	30°	54	2 1/5"	MSCFAN	7738-4654A1-R48

Rods	Dimensions D					Part No.
	L mm	ft	in	D mm	in	

Drifter rod, T35 - Round 39 - R35						
-----------------------------------	--	--	--	--	--	--

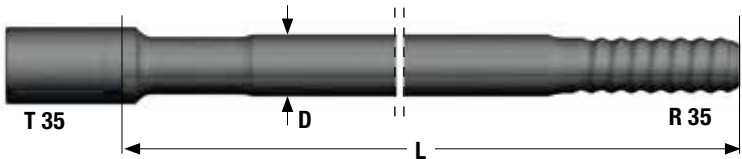
	4305	14'	1 1/2"	39	1 1/2"	7327-5243-20
	4915	16'	1 1/2"	39	1 1/2"	7327-5249-20
	5525	18'	1 1/2"	39	1 1/2"	7327-5255-20
	6135	20'	1 1/2"	39	1 1/2"	7327-5261-20

Flushing hole Ø 14,5 mm, Female end Ø 48,2 mm

Drifter Extension rod, T35 - Round 39 - T35						
---	--	--	--	--	--	--

	3050	10'	–	39	1 1/2"	7327-4731-20
	3660	12'	–	39	1 1/2"	7327-4737-20
	4265	14'	–	39	1 1/2"	7327-4743-20
	4875	16'	–	39	1 1/2"	7327-4749-20

Flushing hole Ø 14,5 mm, Female end Ø 48,2 mm

R35 (1 3/8")

DRIFTING AND TUNNELING

Sandvik drifter bits

Sandvik bits for drifting and tunneling are available in four basic designs



Type 52

Designed for maximum bit life in hard and abrasive rock



Type 53

All-round design with a good trade off between speed and bit life length for hard to medium hard rock



Type 54

All-round design with high penetration rate for hard to medium hard rock

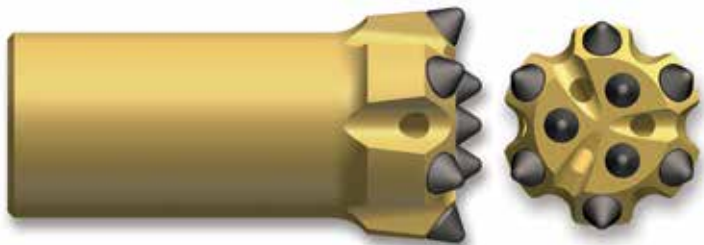

Type 55

Designed for maximum penetration rate in softer and less abrasive rock formations



THE RIGHT SOLUTIONS FOR INCREASED PRODUCTIVITY

Sandvik GT60 enables drilling of holes from 92 mm to 152 mm in diameter. By using a GT60 tool system when drilling the typical T51 hole size (102 mm), hole straightness can be greatly improved – thanks to the much stiffer and stable rod package.

Sandvik GT60 tools system also offers excellent energy transfer efficiency all the way from rock drill to hole bottom, reducing fuel costs and environmental impact.

Increased energy transfer efficiency is key to get the best penetration rate possible from every drilling rig.

A drill string with Sandvik MF-rods offers stiffer connections than a string with separate coupling sleeves due to the 50% reduction in thread play.

BENEFITS WITH SANDVIK TOOLS IN BENCH DRILLING

- Using Sandvik rock tools gives a lower total operating cost.
- Longer service life of drill steel components (reduced drilling tool cost).
- Less downtime – improved productivity.
- Improved safety – better blasting control.
- Less hole deviation which gives more well balanced fragmentation (higher productivity in crushers).
- Reduced consumption of explosives (less specific charging), which accounts for 40–50% of the total drilling and blasting costs.

BOOSTS DRILLING PERFORMANCE TO MAKE OPERATIONS SIMPLER AND PRODUCTIVE

At Sandvik we have several types of specially designed drilling tools. Tools that offer solutions to minimise hole deviation and optimise drilling patterns. The results, improved hole straightness, superior energy transmission and higher drilling efficiency. Our in-house manufacturing facilities for steel production, machining and tailoring together with our research and development, gives us a competitive edge with product solutions tailored for rock drilling professionals.

R32 (1 1/4")	48
T35(1 3/8")	50
T38 (1 1/2")	51
T45 (1 3/4")	53
T51 (2")	55
SANDVIK GT60	57



BENCH DRILLING



R32 (1 1/4")

Bits	Flushing hole, mm		Buttons, mm		Angle	Dimensions D		Bit Classification	Part No.
	Front No Size	Gauge No Size	Front No Size	Gauge No Size		mm	in		
Button bit, regular skirt									
	3x6	1x6	3x9	6x10	35°	51	2"	HMCA	7733-1651A-S48
	3x6	1x6	3x9	6x10	40°	51	2"	MSCAN	7733-1651A-R48
	3x6	1x6	3x10	6x11	35°	57	2 1/4"	HMCA	7733-1657A-S48
	3x7	–	3x11	6x12	30°	64	2 1/2"	HMCVA	7733-1664-S48
	4x7	–	5x11	8x12	35°	76	3"	HMCVA	7733-1876-S48
	3x6	1x6	3x9	6x10	40°	51	2"	SCFN	7733-5551A-C60
	3x6	1x6	3x10	6x10	40°	57	2 1/4"	SCFN	7733-5557A-C60
	3x8	1x8	3x10	6x11	40°	64	2 1/2"	SCFN	7733-5564A-C60
Button bit, Retrac									
	3x6	–	3x9	6x10	35°	51	2"	HMCFA	7733-4651-S48
	3x6	–	3x9	6x10	35°	51	2"	MSCFAN	7733-4651-R48
	4x7	–	5x9	8x10	30°	64	3 1/2"	HMCFVA	7733-4864-S48
Cross bit									
	1x5	2x7.5	–	–	–	51	2"	HMCFA	7733-1451-42

R32 (1 1/4")

BENCH DRILLING

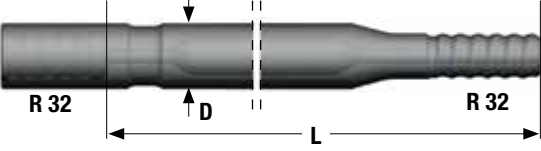
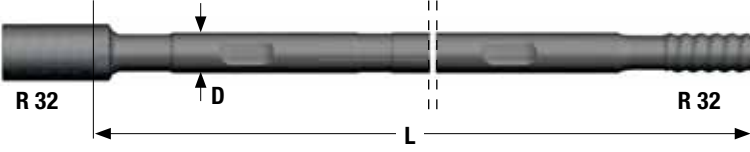
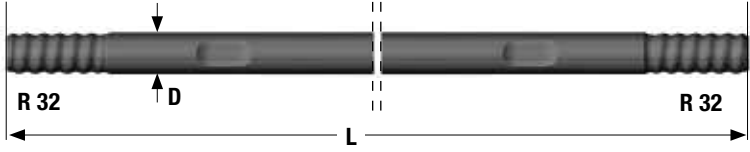
R32 (1 1/4")

Rods	Dimensions D						Part No.
	Bit dia. mm	L mm	ft	in	D mm	in	
Guide tube							
 <p>Female end Ø 46 mm</p>	51-64	1830	6'	-	46	1 3/4"	7953-4618-20
MF-rod, R32 - round 32 - R32							
 <p>Flushing hole Ø 9.2 mm. Wrench flat 25.4 mm. Female end Ø 45 mm</p>	3050	10'	-	-	32	1 1/4"	7853-5131-20
	3660	12'	-	-	32	1 1/4"	7853-5137-20
Extension rod, R32 - round 32 - R32							
 <p>Flushing hole Ø 11.7 mm. Wrench flat 25.4 mm</p>	2440	8'	-	-	32	1 1/4"	7853-3324-30
	3050	10'	-	-	32	1 1/4"	7853-3331-30
	3660	12'	-	-	32	1 1/4"	7853-3337-30
Coupling sleeve R32							
	150	-	5 29/32"	-	44	1 47/64"	7993-3644

BENCH DRILLING

T35 (I 3/8")

Bits	Flushing hole, mm		Buttons, mm		Angle	Dimensions D		Bit Classification	Part No.
	Front No Size	Gauge No Size	Front No Size	Gauge No Size		mm	in		

Button bit, regular skirt

	3x6	1x6	3x9	6x10	35°	54	2 1/2"	HMCFVAN	7517-1654A-S48
--	-----	-----	-----	------	-----	----	--------	---------	----------------

Button bit, Retrac

	3x6	–	3x9	6x10	35°	54	2 1/6"	MSCFAN	7517-4654-R48
	3x7	–	3x10	6x11	35°	57	2 1/4"	MSCFAN	7517-4657-R48

Rods

Rods	Dimensions D					Part No.
	L mm	ft	in	D mm	in	

MF-rod, T35 - round 39 - T35

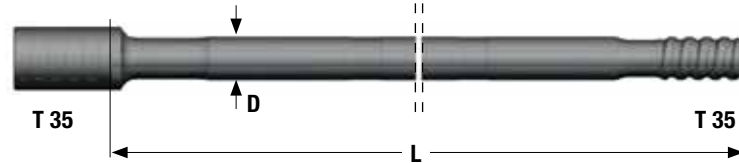
	3050	10'	-	39	1 1/2"	7327-4731-20
	3660	12'	-	39	1 1/2"	7327-4737-20

Female end Ø 48,2 mm. Flushing hole Ø 14,5 mm

BENCH DRILLING

T38 (1 1/2")

Bits	Flushing hole, mm		Buttons, mm		Angle	Dimensions D		Bit Classification	Part No.
	Front No Size	Gauge No Size	Front No Size	Gauge No Size		mm	in		
Button bit, regular skirt									
	3x8	–	3x11	6x12	30°	64	2 1/2"	HMCVAN	7514-1664-S48
	3x8	–	3x11	6x12	35°	64	2 1/2"	MSCAN	7514-1664-R48
	4x8	–	5x10	8x11	30°	70	2 3/4"	HMCVAN	7514-1870-S48
	4x8	–	5x11	8x12	35°	76	3"	HMCVAN	7514-1876-S48
	4x8	–	5x11	8x11	40°	76	3"	MSCAN	7514-1876-R48
	4x9	–	5x12	8x12	35°	89	3 1/2"	HMCVAN	7514-1889-S48
	2x11	1x6	4x10	8x10	30°	64	2 1/2"	HMCAN	7514-2664A-S48
	2x11	1x6	6x10	8x11	35°	76	3"	HMCAN	7514-2676A-S48
	3x8	1x8	3x10	6x11	40°	64	2 1/2"	SCFN	7514-5564A-C60
	4x8	1x8	4x10	8x11	40°	76	3"	SCFN	7514-5576A-C60
Button bit, Retrac									
	3x8	–	3x11	6x12	30°	64	2 1/2"	HMCVFAN	7514-4664-S48
	4x8	–	5x9	8x10	35°	64	2 1/2"	MSCFAN	7514-4864-R48
	4x8	–	5x10	8x11	30°	70	2 3/4"	HMCVFAN	7514-4870-S48
	4x8	–	5x11	8x12	35°	76	3"	HMCVFAN	7514-4876-S48
	4x8	–	5x11	8x11	35°	76	3"	MSCFAN	7514-4876-R48
	2x10	1x6	4x10	8x10	30°	64	2 1/2"	HMCVFAN	7514-7864A-S48
	2x11	1x6	6x10	8x11	35°	76	3"	HMCVFAN	7514-7876A-S48
X bit									
	1x7.5	2x7.5	–	–	–	64	2 1/2"	–	7514-4064-11

T38 (1 1/2")

BENCH DRILLING

T38 (1 1/2")

Rods	Dimensions D						Part No.
	Bit dia. mm	L mm	ft	in	D mm	in	



Guide tube							
64-76	3660	12'	–	56	2 13/64"	7955-5637-20	

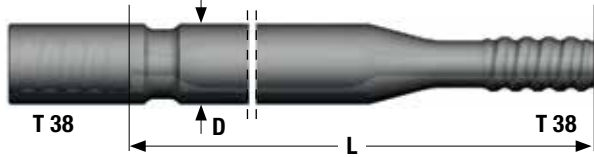

Female end OD 56 mm

MF-rod, T38 - round 39 - T38

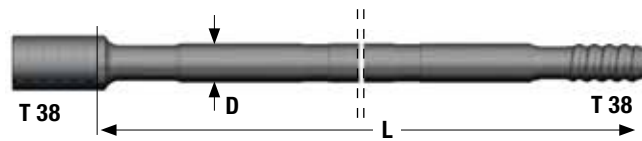

3050	10'	–	39	1 1/2"	7324-4731-70	
3660	12'	–	39	1 1/2"	7324-4737-70	
4265	14'	–	39	1 1/2"	7324-4743-70	

Flushing hole Ø 14.5 mm. Female end OD 56 mm

Extension rod, T38 - round 39 - T38

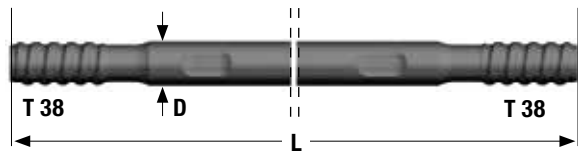

3050	10'	–	39	1 1/2"	7324-4331C-30	
3660	12'	–	39	1 1/2"	7324-4337C-30	

Flushing hole Ø 14.5 mm. Wrench flat 32 mm

Light extension rod, T38 - Hex 32 - T38

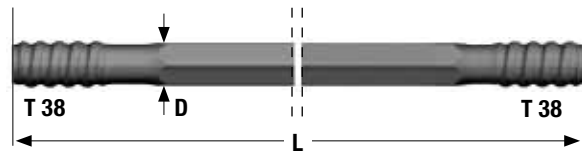

3050	10'	–	32	1 1/4"	7324-6931-20	
------	-----	---	----	--------	--------------	--

Flushing hole Ø 9.6 mm

Coupling sleeve T38

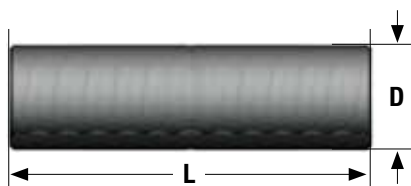



191	–	7 1/2"	55	2 5/32"	7314-3355	
-----	---	--------	----	---------	-----------	--

BENCH DRILLING

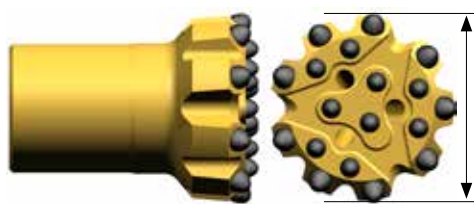

T45 (1 3/4")

Bits	Flushing hole, mm		Buttons, mm		Angle	Dimensions D		Bit Classification	Part No.
	Front No Size	Gauge No Size	Front No Size	Gauge No Size		mm	in		

Button bit, regular skirt

	4x8	–	5x10	8x11	30°	70	2 3/4"	HMCVAN	7515-1870-S48
	4x8	–	5x11	8x12	35°	76	3"	HMCVAN	7515-1876-S48
	4x8	–	5x11	8x12	35°	76	3"	MSCAN	7515-1876-R48
	4x9	–	5x13	8x13	35°	89	3 1/2"	HMCVAN	7515-1889-S48
	4x9	–	5x13	8x13	40°	89	3 1/2"	HMCAN	7515-1889-R48
	3x10	–	9x11	9x13	35°	102	4"	HMCVAN	7515-1902-S48
	3x10	–	9x11	9x13	40°	102	4"	MSCAN	7515-1902-R48
	2x12	1x7.5	6x10	8x11	35°	76	3"	HMCAN	7515-2676A-S48
	3x10	1x7.5	6x10	9x11	35°	89	3 1/2"	HMCAN	7515-2689A-S48
	4x8	1x8	4x10	8x11	40°	76	3"	SCFN	7515-5576A-C60

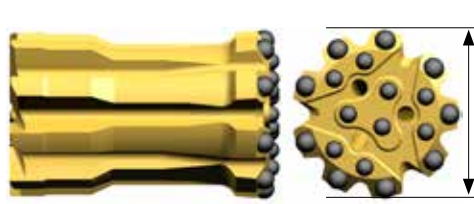
Button bit, Retrac

	4x8	–	5x10	8x11	35°	70	2 3/4"	MSCFAN	7515-4870-R48
	4x8	–	5x11	8x12	35°	76	3"	HMCVFAN	7515-4876-S48
	4x8	–	5x11	8x12	35°	76	3"	MSCFAN	7515-4876-R48
	4x9	–	5x13	8x13	35°	89	3 1/2"	HMCVFAN	7515-4889-S48
	4x9	–	5x13	8x13	40°	89	3 1/2"	MSCFAN	7515-4889-R48
	3x10	–	9x11	9x13	35°	102	4"	HMCVFAN	7515-4902-S48
	3x10	–	9x11	9x13	40°	102	4"	MSCFAN	7515-4902-R48
	2x11	1x6	6x10	8x11	35°	76	3"	HMCVFAN	7515-7876A-S48
	3x10	1x8	6x10	9x11	35°	89	3 1/2"	HMCVFAN	7515-7889A-S48

BENCH DRILLING

T45 (1 3/4")

T45 (1 3/4")

Rods	Dimensions D					Part No.
	Bit dia. mm	L mm	ft	in	D mm	

Guide tube

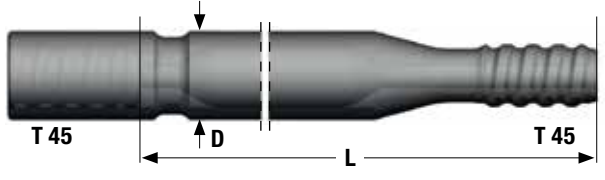

76-89	3660	12'	–	63	2 1/2"	7956-6337-70
89-102	3660	12'	–	76	3"	7956-7637-70

Female end Ø 63 mm / 76 mm

MF-rod, T45 - round 46 - T45

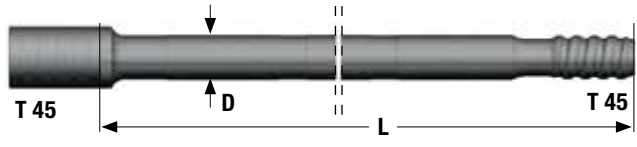

3050	10'	–	46	1 3/4"	7325-7731-70
3660	12'	–	46	1 3/4"	7325-7737-70
4265	14'	–	46	1 3/4"	7325-7743-70
6095	20'	–	46	1 3/4"	7325-7761-70

Flushing hole Ø 17 mm. Female end Ø 63 mm

Extension rod, T45 - round 46 - T45

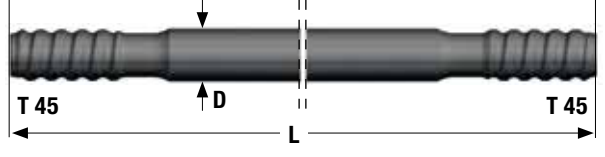

3050	10'	–	46	1 3/4"	7325-7331C-30
3660	12'	–	46	1 3/4"	7325-7337C-30
4265	14'	–	46	1 3/4"	7325-7343C-30

Flushing hole Ø 17 mm

Coupling sleeve T45

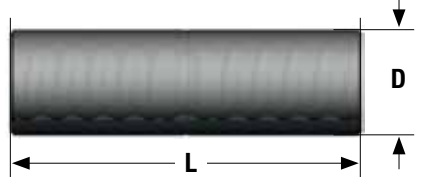

210	–	8 1/8"	63	2 31/64"	7315-3663
-----	---	--------	----	----------	-----------

BENCH DRILLING

T51 (2")

Bits	Flushing hole, mm		Buttons, mm		Angle	Dimensions D		Bit Classification	Part No.
	Front No Size	Gauge No Size	Front No Size	Gauge No Size		mm	in		

Button bit, regular skirt

	4x10	–	5x13	8x13	35°	89	3 1/2"	HMCVAN	7516-1889-S48
	4x10	–	5x13	8x13	40°	89	3 1/2"	MSCAN	7516-1889-R48

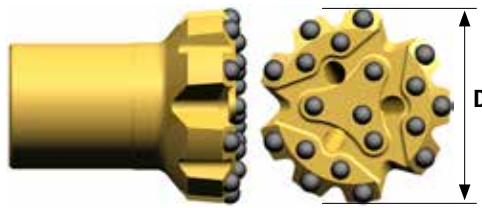
	3x13	–	9x11	9x13	40°	102	4"	MSCAN	7516-1902-R48
	3x13	–	9x11	9x13	35°	102	4"	HMCVAN	7516-1902-S48
	3x14	–	10x12	9x14	35°	115	4 1/2"	HMCVAN	7516-1915-S48
	3x14	–	10x13	9x14	35°	127	5"	HMCVAN	7516-1927-S48

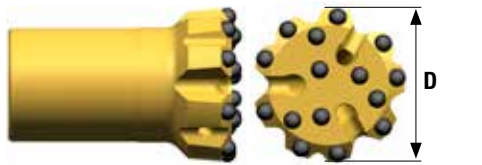
	3x12	1x8	6x10	9x11	35°	89	3 1/2"	HMCAN	7516-2689A-S48
	3x12	1x8	6x12	9x12	35°	102	4"	HMCAN	7516-2602A-S48

Button bit, Retrac

	4x10	–	5x13	8x13	35°	89	3 1/2"	HMCVFAN	7516-4889-S48
	4x10	–	5x13	8x13	40°	89	3 1/2"	MSCFAN	7516-4889-R48

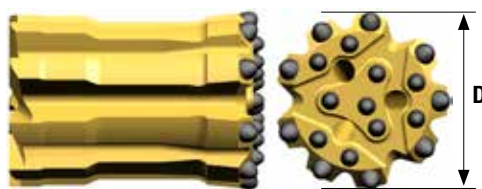
	3x13	–	9x11	9x13	40°	102	4"	MSCFAN	7516-4902-R48
	3x13	–	9x11	9x13	35°	102	4"	HMCVFAN	7516-4902-S48
	3x14	–	10x12	9x14	40°	115	4 1/2"	HMCVFAN	7516-4915-R48
	3x14	–	10x12	9x14	35°	115	4 1/2"	HMCVFAN	7516-4915-S48
	3x14	–	10x13	9x14	35°	127	5"	HMCVFAN	7516-4927-S48

	3x12	1x8	6x10	9x11	35°	89	3 1/2"	HMCVFAN	7516-7889A-S48
---	------	-----	------	------	-----	----	--------	---------	----------------

BENCH DRILLING

T51 (2")

Rods	Dimensions D						Part No.
	Bit dia. mm	L mm	ft	in	D mm	in	

Guide tube

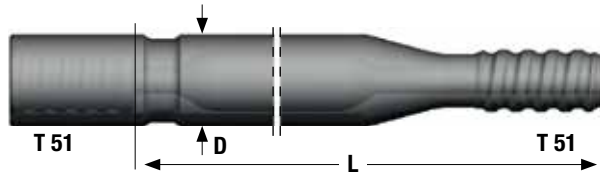

89-102	3660	12'	–	76	3"	7957-7637-70
102-127	3660	12'	–	87	3 1/2"	7957-8737-70

Female end \varnothing 76 / 87 mm

MF-rod, T51 - round 52 - T51

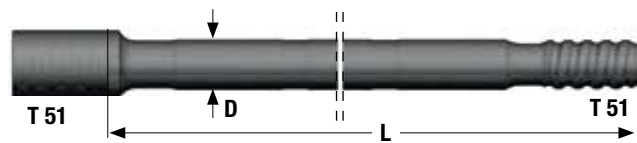

3660	12'	–	52	2"	7326-5537-70
4265	14'	–	52	2"	7326-5543-70
6095	20'	–	52	2"	7326-5561-70

Flushing hole \varnothing 21,5 mm. Female end \varnothing 71 mm

Extension rod, T51 - round 52 - T51

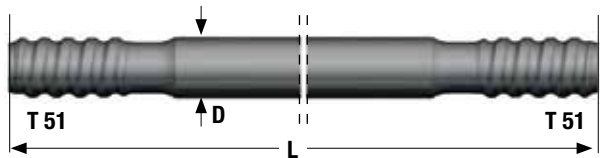

3050	10'	–	46	1 3/4"	7326-7331C-30
3660	12'	–	46	1 3/4"	7326-7337C-30
4265	14'	–	46	1 3/4"	7326-7343C-30

Flushing hole \varnothing 21.5 mm

Coupling sleeve T51

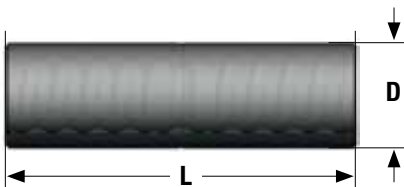

225	–	8 7/8"	71	2 51/64"	7316-3671
225	–	8 7/8"	76	3"	7316-3676

BENCH DRILLING

Sandvik GT60

Bits	Flushing hole, mm		Buttons, mm		Angle	Dimensions D		Bit Classification	Part No.
	Front No Size	Gauge No Size	Front No Size	Gauge No Size		mm	in		

Button bit, regular skirt



4x11	–	6x12	8x14	35°	92	3 5/8"	HMSCVA	7620-1892-S48
4x11	–	6x12	8x14	35°	96	3 3/4"	HMSCVA	7620-1896-S48



3x14	–	9x11	9x13	35°	102	4"	HMSCVA	7620-1902-S48
3x14	–	10x12	9x14	35°	115	4 1/2"	HMSCVA	7620-1915-S48
3x14	–	10x12	9x14	40°	115	4 1/2"	MSCFAN	7620-1915-R48
3x14	–	10x14	9x16	35°	127	5"	HMSCVA	7620-1927-S48
3x14	–	10x14	9x16	35°	140	5 1/2"	HMSCVA	7620-1940-S48
3x14	–	12x14	9x16	35°	152	6"	HMSCVA	7620-1952-S48

Button bit, Retrac

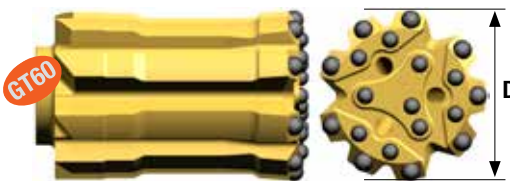

3x14	–	9x11	9x13	35°	102	4"	HMSCFVA	7620-4902-S48
3x14	–	10x12	9x14	40°	115	4 1/2"	MSCFAN	7620-4915-R48
3x14	–	10x12	9x14	35°	115	4 1/2"	HMSCFVA	7620-4915-S48
3x14	–	10x14	9x16	35°	127	5"	HMSCFVA	7620-4927-S48
3x14	–	10x14	9x16	35°	127	5"	HMSCFVA	7620-4927-S55
3x14	–	10x14	9x16	35°	140	5 1/2"	HMSCFVA	7620-4940-S48
3x14	–	12x14	9x16	35°	152	6"	HMSCFVA	7620-4952-S48



2x14	–	9x12	9x12	35°	92	3 5/8"	HMSCFAN	7620-8792-S48
2x14	–	9x12	9x12	40°	92	3 5/8"	MSCFAN	7620-8792-R48
2x14	–	9x12	9x12	35°	96	3 3/4"	HMSCFAN	7620-8796-S48
2x14	–	9x12	9x12	40°	96	3 3/4"	MSCFAN	7620-8796-R48
2x14	–	10x12	9x13	40°	102	4"	MSCFAN	7620-8702-R48



3x13	–	6x13	9x16	35°	115	4 1/2"	HMCFVA	7620-8115-S55
------	---	------	------	-----	-----	--------	--------	---------------

BENCH DRILLING

Sandvik GT60

Rods	Dimensions D					Part No.
	L mm	ft	in	D mm	in	

MF-rod, GT60 - round 60 - GT60. For bits from 96 mm.

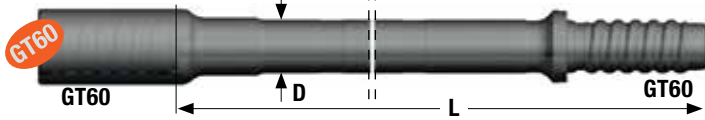

Female end \varnothing 85 mm. Flushing hole \varnothing 22,5 mm

3660	12'	-	60	2 3/8"	7610-1137-70
4265	14'	-	60	2 3/8"	7610-1143-70
6095	20'	-	60	2 3/8"	7610-1161-70

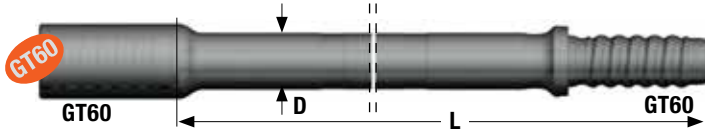

Female end \varnothing 85 mm. Flushing hole \varnothing 25 mm

4265	14'	-	64	2 1/2"	7610-1243-70
------	-----	---	----	--------	--------------

MF-rod, GT60 - round 60 - GT60. For 92-115 mm bits.

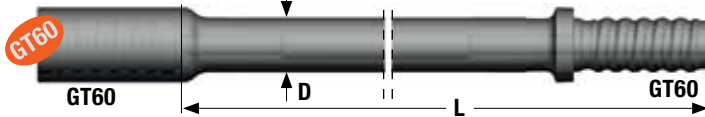

Female end \varnothing 82 mm. Flushing hole \varnothing 22,5 mm

4265	14'	-	60	2 3/8"	7610-1443-70
------	-----	---	----	--------	--------------

Pilot tube - GT60.

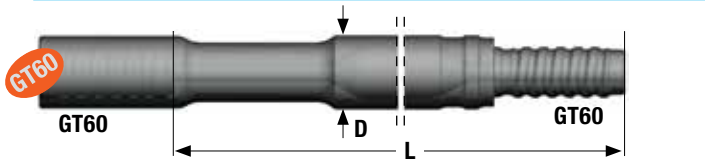

Female end \varnothing 85 mm (82 mm on 76 mm tubes)

4265	14'	-	87	3 1/2"	7640-8743-70
5335	17'	6"	76	3"	7640-7653-70

Drill tube

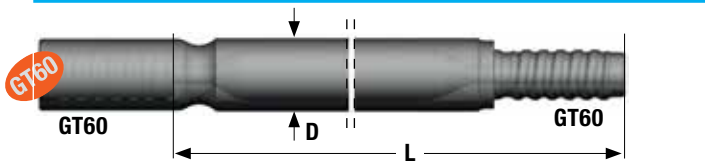

Always use with tube shank adapter 7600-6030-01 (HL1500, 1560) or 7600-6031-01 (HL1000, 1010)

4265	14'	-	87	3 1/2"	7660-8743-71
------	-----	---	----	--------	--------------

.....

THE POWER TO MEET EVERY CRITERIA

Production drilling is at the very heart of the mine so it's critical that every consideration is given to using products that supply high quality and high reliability. The developments in underground mining points to large scale production with fewer sublevels, longer holes and more selective mining – which make drilling accuracy more important than ever. Many factors influence the straightness of the drill hole; rock/ore properties, drilling method, power and set-up of the drill rig and, correct choice of the drilling tools. In this context a Sandvik MF rod string is a tolerant and forgiving tool system. And, as long as satisfactory results are achieved, this system should be regarded as a first choice. And where hole straightness is paramount – a Sandvik tube string system is the recommended choice.

With our unique in-house manufacturing facilities for producing, machining and tailoring steel, we are able to modify the metallurgical properties of all crucial Sandvik MF rod components. Therefore all Sandvik rod-strings are given specific material characteristics to maximize wear, fatigue and corrosion resistance. Ultimately boosting drilling performance, to make drilling operations simple and secure high productivity. In long-hole production drilling, the main advantages of the Sandvik tube drilling system is the high rate of penetration; the straightness, quality of the drill-holes and the low total production cost. Hole diameter ranges from 76 to 115 mm and, a correctly assembled tube string in a stable rig permits accurate drilling of holes up to 60 meters.

.....



WHERE QUALITY COUNTS DILUTION IS PRIMARILY CAUSED BY DEVIATION

One question commonly asked is whether it's possible to increase the output a long hole-drilling. The answer is an emphatic yes. It's all to do with hole straightness and direction. Accurate placement of explosives energy will protect weak ground conditions. The ultimate reason for efficient, accurate drilling is mine profitability. Hole deviation adversely effects profitability in the form of poor fragmentation, low ore recovery and ore dilution. Using Sandvik quality tools has been proven to reduce deviation by up to 40%.

R32 (1 1/4")	62
T35 (1 3/8")	64
T38 (1 1/2")	65
T45 (1 3/4")	67
T51 (2")	69
T45 (1 3/4") TUBE DRILLING TOOLS	71
ST58 (2 1/4") TUBE DRILLING TOOLS	72
ST68 (2 3/4") TUBE DRILLING TOOLS	73



LONG HOLE DRILLING UNDERGROUND

R32 (1 1/4")

Bits	Flushing hole, mm		Buttons, mm		Angle	Dimensions D		Bit Classification	Part No.
	Front No Size	Gauge No Size	Front No Size	Gauge No Size		mm	in		
Button bit, Regular skirt									
	3x6	1x6	3x9	6x10	35°	51	2"	HMCA	7733-1651A-S48
	3x6	1x6	3x9	6x10	40°	51	2"	MSCAN	7733-1651A-R48
	3x6	1x6	3x10	6x11	35°	57	2 1/4"	HMCA	7733-1657A-S48
	3x7	–	3x11	6x12	30°	64	2 1/2"	HMCVA	7733-1664-S48
	4x7	–	5x11	8x12	35°	76	3"	HMCVA	7733-1876-S48
	3x6	1x6	3x9	6x10	40°	51	2"	SCFN	7733-5551A-C60
	3x6	1x6	3x10	6x10	40°	57	2 1/4"	SCFN	7733-5557A-C60
	3x8	1x8	3x10	6x11	40°	64	2 1/2"	SCFN	7733-5564A-C60
Button bit, Retrac skirt									
	3x6	–	3x9	6x10	35°	51	2"	HMCFA	7733-4651-S48
	3x6	–	3x9	6x10	35°	51	2"	MSCFAN	7733-4651-R48
	4x7	–	5x9	8x10	30°	64	3 1/2"	HMCFVA	7733-4864-S48
Cross bit									
	1x5	2x7.5	–	–	–	51	2"	HMCFA	7733-1451-42

LONG HOLE DRILLING UNDERGROUND

R32 (1 1/4")

Rods	Dimensions D						Part No.
	Bit dia. mm	L mm	ft	in	D mm	in	

Guide tube

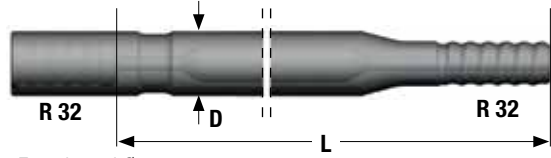

51-64	1830	6'	–	46	1 3/4"	7953-4618-20
-------	------	----	---	----	--------	--------------

Female end Ø 46 mm

MF-rod, R32 - round 32 - R32

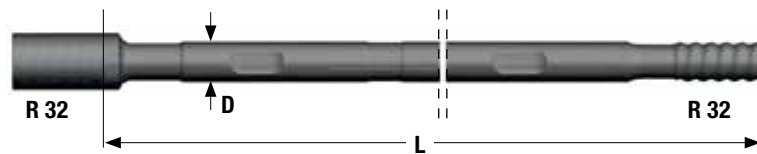

915	3'	–	32	1 1/4"	7853-5109-20
1220	4'	–	32	1 1/4"	7853-5112-20
1525	5'	–	32	1 1/4"	7853-5115-20
1830	6'	–	32	1 1/4"	7853-5118-20

Flushing hole Ø 11.7 mm. Wrench flat 25.4 mm. Female end Ø 45 mm

Extension rod, R32 - round 32 - R32

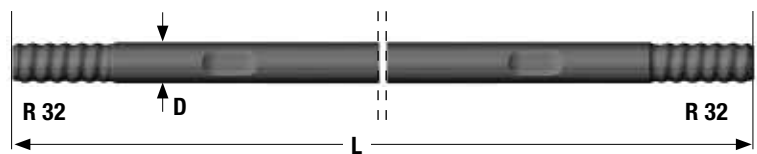

915	3'	–	32	1 1/4"	7853-3309-20
1220	4'	–	32	1 1/4"	7853-3312-20
1525	5'	–	32	1 1/4"	7853-3315-20
1830	6'	–	32	1 1/4"	7853-3318-20

Flushing hole Ø 11.7 mm. Wrench flat 25.4 mm

Coupling sleeve R32



150	–	5 29/32"	44	1 47/64"	7993-3644
-----	---	----------	----	----------	-----------

Pilot adapter	Thread	Dimensions D				Part No.
		L mm	ft	in	D mm	

Pilot adapter for reaming of 51 mm (2") pilot holes



R32	–	–	–	47	1 7/8"	7823-3647
-----	---	---	---	----	--------	-----------

Reaming bit	Buttons, mm		Angle	Dimensions D		Bit Classification	Part No.
	Front No Size	Gauge No Size		mm	in		

Reaming bit



4x12	8x12	35°	102	4"	–	7723-4802-S48
4x12	8x12	35°	127	5"	–	7723-4827-S48

LONG HOLE DRILLING UNDERGROUND

T35 (1 3/8")

Bits	Flushing hole, mm		Buttons, mm		Angle	Dimensions D		Bit Classification	Part No.
	Front No Size	Gauge No Size	Front No Size	Gauge No Size		mm	in		

Button bit, regular skirt									
	3x6	1x6	3x9	6x10	35°	64	2 1/2"	HMCFVAN	7517-1654A-S48

Button bit, Retrac T35									
	3x6	-	3x9	6x10	35°	54	2 1/6"	MSCFAN	7517-4654-R48
	3x7	-	3x10	6x11	35°	57	2 1/4"	MSCFAN	7517-4657-R48

Rods	Dimensions D					Part No.
	L mm	ft	in	D mm	in	

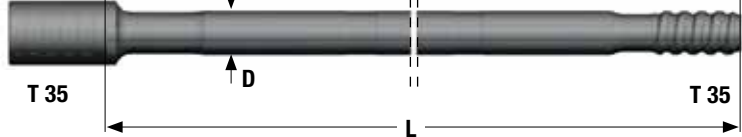
MF-rod, T35 - Round 39 - T35						
	1830	6'	-	39	1 1/2"	7327-4718-20

Female end Ø 48,2 mm. Flushing hole Ø 14,5 mm

LONG HOLE DRILLING UNDERGROUND

T38 (1 1/2")

Bits	Flushing hole, mm		Buttons, mm		Angle	Dimensions D		Bit Classification	Part No.
	Front No Size	Gauge No Size	Front No Size	Gauge No Size		mm	in		
Button bit, Regular skirt									
	3x8	–	3x11	6x12	30°	64	2 1/2"	HMCVAN	7514-1664-S48
	3x8	–	3x11	6x12	35°	64	2 1/2"	MSCAN	7514-1664-R48
	4x8	–	5x10	8x11	30°	70	2 3/4"	HMCVAN	7514-1870-S48
	4x8	–	5x11	8x12	35°	76	3"	HMCVAN	7514-1876-S48
	4x8	–	5x11	8x11	40°	76	3"	MSCAN	7514-1876-R48
	4x9	–	5x12	8x12	35°	89	3 1/2"	HMCVAN	7514-1889-S48
	2x11	1x6	4x10	8x10	30°	64	2 1/2"	HMCAN	7514-2664A-S48
	2x11	1x6	6x10	8x11	35°	76	3"	HMCAN	7514-2676A-S48
	3x8	1x8	3x10	6x11	40°	64	2 1/2"	SCFN	7514-5564A-C60
	4x8	1x8	4x10	8x11	40°	76	3"	SCFN	7514-5576A-C60
Button bit, Retrac skirt									
	3x8	–	3x11	6x12	30°	64	2 1/2"	HMCVFAN	7514-4664-S48
	4x8	–	5x9	8x10	35°	64	2 1/2"	MSCFAN	7514-4864-R48
	4x8	–	5x10	8x11	30°	70	2 3/4"	HMCVFAN	7514-4870-S48
	4x8	–	5x11	8x12	35°	76	3"	HMCVFAN	7514-4876-S48
	4x8	–	5x11	8x11	35°	76	3"	MSCFAN	7514-4876-R48
	4x8	–	5x11	8x11	35°	76	3"	MSCFAN	7514-4876-R48
	2x10	1x6	4x10	8x10	30°	64	2 1/2"	HMCVFAN	7514-7864A-S48
	2x11	1x6	6x10	8x11	35°	76	3"	HMCVFAN	7514-7876A-S48
X bit									
	1x7.5	2x7.5	–	–	–	64	2 1/2"	–	7514-4064-11

T38 (1 1/2")

LONG HOLE DRILLING UNDERGROUND

T38 (1 1/2")

Rods	Dimensions D						Part No.
	Bit dia. mm	L mm	ft	in	D mm	in	
Guide tube	64-76	1830	6'	–	56	2 13/64"	7955-5618-20

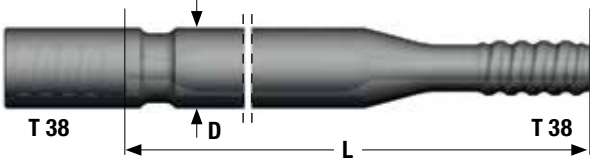

Female end OD 56 mm

MF-rod, T38 - round 39 - T38							
	1220	4'	–		39	1 1/2"	7324-4712C-20
	1525	5'	–		39	1 1/2"	7324-4715C-20
	1830	6'	–		39	1 1/2"	7324-4718C-20

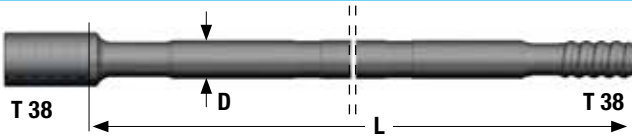

Flushing hole Ø 14.5 mm. Female end OD 56 mm

Pilot adapter	Thread	Dimensions D					Part No.
		L mm	ft	in	D mm	in	
Pilot adapter for reaming of 51 mm (2") pilot holes	R38	–	–	–	47	1 7/8"	7823-2647



Reamer	Buttons, mm		Angle	Dimensions D		Bit Classification	Part No.
	Front No Size	Gauge No Size		mm	in		
Reaming bit	4x12	8x12	35°	102	4"	–	7723-4802-S48
	4x12	8x12	35°	127	5"	–	7723-4827-S48



LONG HOLE DRILLING UNDERGROUND

T45 (1 3/4")

Bits	Flushing hole, mm		Buttons, mm		Angle	Dimensions D		Bit Classification	Part No.
	Front No Size	Gauge No Size	Front No Size	Gauge No Size		mm	in		
Button bit, Regular skirt									
	4x8	–	5x10	8x11	30°	70	2 3/4"	HMCVAN	7515-1870-S48
	4x8	–	5x11	8x12	35°	76	3"	HMCVAN	7515-1876-S48
	4x8	–	5x11	8x12	35°	76	3"	MSCAN	7515-1876-R48
	4x9	–	5x13	8x13	35°	89	3 1/2"	HMCVAN	7515-1889-S48
	4x9	–	5x13	8x13	40°	89	3 1/2"	HMCAN	7515-1889-R48
	3x10	–	9x11	9x13	35°	102	4"	HMCVAN	7515-1902-S48
	3x10	–	9x11	9x13	40°	102	4"	MSCAN	7515-1902-R48
	2x12	1x7.5	6x10	8x11	35°	76	3"	HMCAN	7515-2676A-S48
	3x10	1x7.5	6x10	9x11	35°	89	3 1/2"	HMCAN	7515-2689A-S48
	4x8	1x8	4x10	8x11	40°	76	3"	SCFN	7515-5576A-C60
Button bit, Retrac skirt									
	4x8	–	5x10	8x11	35°	70	2 3/4"	MSCFAN	7515-4870-R48
	4x8	–	5x11	8x12	35°	76	3"	HMCVFAN	7515-4876-S48
	4x8	–	5x11	8x12	35°	76	3"	MSCFAN	7515-4876-R48
	4x9	–	5x13	8x13	35°	89	3 1/2"	HMCVFAN	7515-4889-S48
	4x9	–	5x13	8x13	40°	89	3 1/2"	MSCFAN	7515-4889-R48
	3x10	–	9x11	9x13	35°	102	4"	HMCVFAN	7515-4902-S48
	3x10	–	9x11	9x13	40°	102	4"	MSCFAN	7515-4902-R48
	2x11	1x6	6x10	8x11	35°	76	3"	HMCVFAN	7515-7876A-S48
	3x10	1x8	6x10	9x11	35°	89	3 1/2"	HMCVFAN	7515-7889A-S48
Reaming bit									
	3x14	–	9x14	–	35°	127	5"	–	7515-5627-S48
	7x14	–	8x14	–	35°	152	6"	–	7515-5652-S48

Pilot diameter: 64 mm

T45 (1 3/4")

LONG HOLE DRILLING UNDERGROUND

T45 (1 3/4")

Rods	Dimensions D						Part No.
	Bit dia. mm	L mm	ft	in	D mm	in	

Guide tube

76-89	1830	6'	-	63	2 31/64"	7956-6318-21
-------	------	----	---	----	----------	--------------

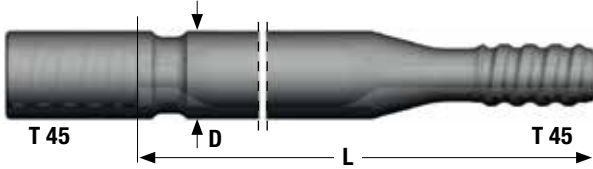

Female end Ø 63 mm

MF-rod, T45 - round 46 - T45



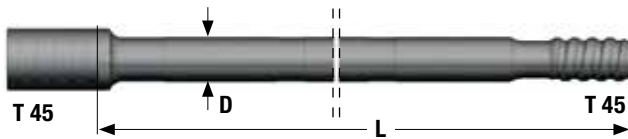

1220	4'	-	46	1 3/4"	7325-7712C-20
1525	5'	-	46	1 3/4"	7325-7715C-20
1830	6'	-	46	1 3/4"	7325-7718C-20

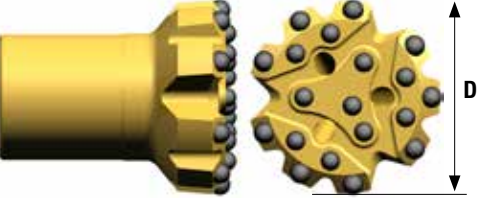

Flushing hole Ø 17 mm. Female end Ø 63 mm

LONG HOLE DRILLING UNDERGROUND

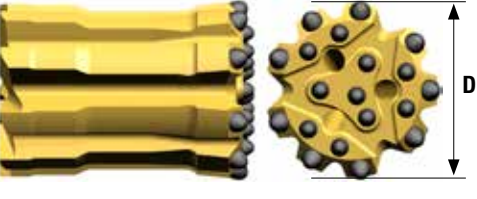
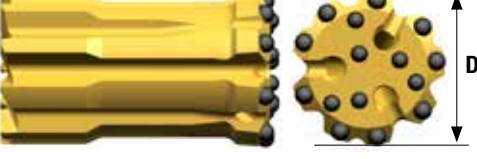
T51 (2")

Bits	Flushing hole, mm		Buttons, mm		Angle	Dimensions D		Bit Classification	Part No.
	Front No Size	Gauge No Size	Front No Size	Gauge No Size		mm	in		
Button bit, Regular skirt									
	4x10	–	5x13	8x13	35°	89	3 1/2"	HMCVAN	7516-1889-S48
	4x10	–	5x13	8x13	40°	89	3 1/2"	MSCAN	7516-1889-R48
	3x13	–	9x11	9x13	40°	102	4"	MSCAN	7516-1902-R48
	3x13	–	9x11	9x13	35°	102	4"	HMCVAN	7516-1902-S48
	3x14	–	10x12	9x14	35°	115	4 1/2"	HMCVAN	7516-1915-S48
	3x14	–	10x13	9x14	35°	127	5"	HMCVAN	7516-1927-S48
	3x12	1x8	6x10	9x11	35°	89	3 1/2"	HMCAN	7516-2689A-S48
	3x12	1x8	6x12	9x12	35°	102	4"	HMCAN	7516-2602A-S48
Button bit, Retrac skirt									
	4x10	–	5x13	8x13	35°	89	3 1/2"	HMCVFAN	7516-4889-S48
	4x10	–	5x13	8x13	40°	89	3 1/2"	MSCFAN	7516-4889-R48
	3x13	–	9x11	9x13	40°	102	4"	MSCFAN	7516-4902-R48
	3x13	–	9x11	9x13	35°	102	4"	HMCVFAN	7516-4902-S48
	3x14	–	10x12	9x14	40°	115	4 1/2"	HMCVFAN	7516-4915-R48
	3x14	–	10x12	9x14	35°	115	4 1/2"	HMCVFAN	7516-4915-S48
	3x14	–	10x13	9x14	35°	127	5"	HMCVFAN	7516-4927-S48
	3x12	1x8	6x10	9x11	35°	89	3 1/2"	HMCVFAN	7516-7889A-S48
	3x12	–	6x12	9x12	35°	102	4"	HMCVFAN	7516-7802-S48
Reaming bit									
	7x14		8x14		35°	152	6"	–	7516-5652-S48

Pilot diameter: 64 mm

LONG HOLE DRILLING UNDERGROUND

T51 (2")

Rods	Dimensions D						Part No.
	Bit dia. mm	L mm	ft	in	D mm	in	

Guide tube							
------------	--	--	--	--	--	--	--

89-102	1830	6'	–	76	3"	7957-7618-20	
--------	------	----	---	----	----	--------------	--

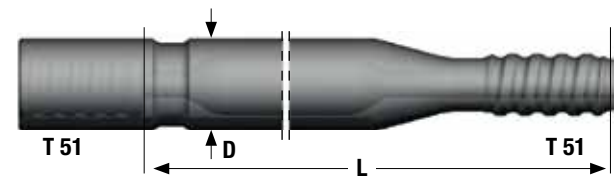

Female end Ø 76

MF-rod, T51 - round 52 - T51							
------------------------------	--	--	--	--	--	--	--

1525	5'	–	52	2"	7326-5515C-20		
1830	6'	–	52	2"	7326-5518C-20		



Flushing hole Ø 21.5 mm. Female end Ø 71 mm

LONG HOLE DRILLING UNDERGROUND

T45 (I 3/4") tube drilling tools

Bits	Flushing hole, mm		Buttons, mm		Angle	Dimensions D		Bit Classification	Part No.
	Front No Size	Gauge No Size	Front No Size	Gauge No Size		mm	in		
XDC, button bit									
	4x7.5	–	6x10	8x11	35°	76	3"	HMCVA	7525-8476-R65



Tubes	Dimensions D					Part No.
	L mm	ft	in	D mm	in	
Drill tube, T45 - Round 65 - T45						
	1525	5'	–	65	2 1/2"	7985-6315-26
	1830	6'	–	65	2 1/2"	7985-6318-26

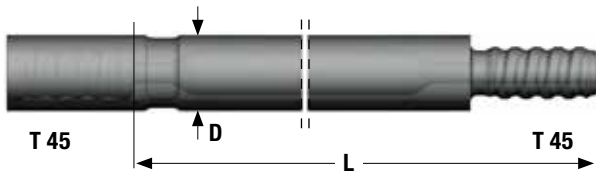

Flushing hole \varnothing 18 mm

LONG HOLE DRILLING UNDERGROUND

ST58 (2 1/4") tube drilling tools

Bits	Flushing hole, mm		Buttons, mm		Angle	Dimensions D		Bit Classification	Part No.
	Front No Size	Gauge No Size	Front No Size	Gauge No Size		mm	in		

XDC, button bit



4x10	–	6x12	8x12	35°	89	3 1/2"	HMCVA	7528-8489-R65
------	---	------	------	-----	----	--------	-------	---------------

XDC, button bit, guide retrac



4x10	–	6x12	8x12	35°	89	3 1/2"	HMCVA	7528-7389-R65
------	---	------	------	-----	----	--------	-------	---------------

Button bit, Heavy Duty



2x15	–	6x12	8x14	35°	89	3 1/2"	HCV	7528-6989-S65
------	---	------	------	-----	----	--------	-----	---------------

Reaming bit



7x14	8x14	35°	152	6"	–	7528-5652-S65
------	------	-----	-----	----	---	---------------

Pilot diameter 76 mm

Tubes	Dimensions D					Part No.
	L mm	ft	in	D mm	in	

Drill tube, ST58 - Round 76 - ST58

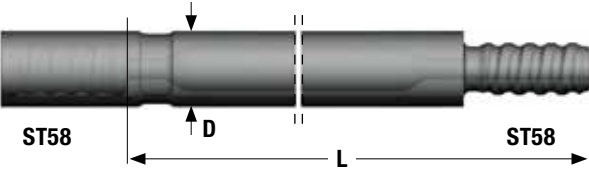

1525	5'	–	76	3"	7378-7615-26
1830	6'	–	76	3"	7378-7618-26

Flushing hole Ø 26 mm

ST58 Tube

LONG HOLE DRILLING UNDERGROUND

ST68 (2 3/4") tube drilling tools

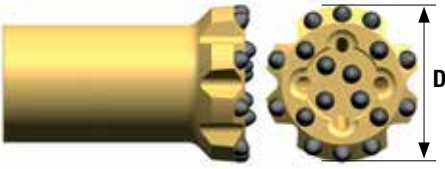
Bits	Flushing hole, mm		Buttons, mm		Angle	Dimensions D		Bit Classification	Part No.
	Front No Size	Gauge No Size	Front No Size	Gauge No Size		mm	in		
XDC, button bit									
	4x10	–	8x12	10x12	35°	102	4"	HMCVA	7529-8402-R65
	4x10	–	8x14	10x14	35°	115	4 1/2"	HMCVA	7529-8415-R65

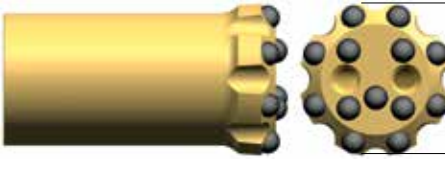
Button bit, Heavy Duty									
	2x15	–	5x14	8x16	35°	102	4"	HCV	7529-6902-S65

XDC, button bit, guide retrac									
	4x10	–	8x12	10x12	35°	102	4"	HMCVA	7529-7302-R65
	4x10	–	8x14	10x14	35°	115	4 1/2"	HMCVA	7529-7315-R65

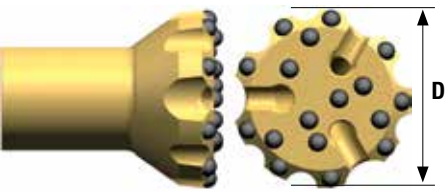
Collaring bit									
	3x18	–	8x16	9x16	35°	152	6"	–	7529-6652-S48

Reaming bit									
	3x16	9x16	35°	152	6"	–	7529-5652C-S65		
	4x14	16x14	35	204	8"	-	7529-5604A-S65		

Pilot diameter 95 mm 7529-5652C-S65

Pilot diameter 137 mm 7529-5604A-S65

Tubes	Dimensions D					Part No.
	L mm	ft	in	D mm	in	
Drill tube, ST68 - Round 87 - ST68						

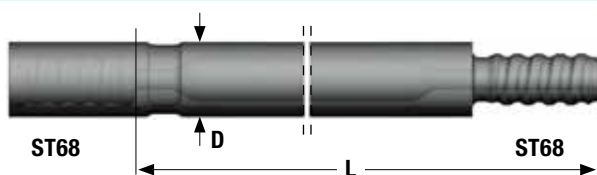

Flushing hole Ø 30 mm

1525	5'	–	87	3 1/2"	7379-8715-26
1525	5'	–	87	3 1/2"	7379-8715-46
1830	6'	–	87	3 1/2"	7379-8718-26
1830	6'	–	87	3 1/2"	7379-8718-46

! Permanent back flow valve.



Internal flushing shank adapters use a water tube inside the rock drill. The tube fits into the end of the shank adapter and is sealed with an O-ring. This allows the water to transfer from the rock drill to shank adapter, which in turn allows it flow through the rest of the drill string.



Shank adapters with external flushing can be identified by machined slots in the center of the adapter. The slots are positioned between seals inside the flushing housing / head of the rock drill.

HIGH PRECISION ROCK DRILLING FOR RELIABLE PERFORMANCE AND LOWER COSTS

While every component in the drill string is crucial, the shank adapter must be engineered to transmit impact energy from the rock-drill piston, as well as rotation torque, into the drill string with no losses. It must withstand and transmit up to 6300 blows per minute from the piston continually and do it with great endurance and dependability. With this in mind, Sandvik manufactures premium quality shank adapters for most brands of rock drills.

HEXAGONAL SHANK ADAPTERS	76
SANDVIK	77
ATLAS COPCO	84
BOART	88
FURUKAWA	89
GARDNER-DENVER, INGERSOLL-RAND & KLEMM	90
MONTABERT	91
SIG	92



Hydraulic shanks generally have at least a 5 to 14-spline configuration. Pneumatic shanks tend to have internal or through-flushing. They can be identified by their lugs or 4-spline configuration.

SHANK ADAPTERS

Hexagonal shank adapters

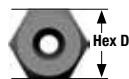

Flushing tube (mm)	Thread	Length (mm)	Part No.
--------------------	--------	-------------	----------

For hexagonal bushing 22 x 108 mm



4.5-5.0	R22	255	7801-6103-11
4.5-5.0	R23	255	7807-6103-11
4.5-5.0	R25	255	7802-6103-11



For hexagonal bushing 25 x 108 mm

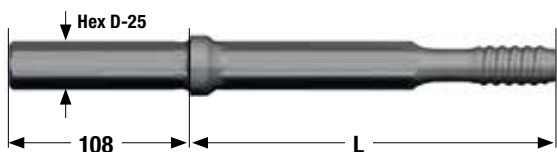

4.5-5.0	R23	255	7807-7103-30
4.5-5.0	R25	255	7802-7103-14



For hexagonal bushing 25 x 159

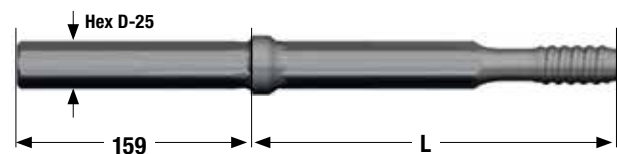

8	R25	255	7802-7103-21
---	-----	-----	--------------

No packing. Not suitable for hydraulic machines with water flushing.

SHANK ADAPTERS

Sandvik

	Applica- tion	Flushing hole (mm)	Thread	Length (mm)	Part No.
HLX 1					
	TU,BO	–	R23	235	7807-7570-01
	TU,BO	–	R25	255	7802-7567-01
	TU,BO	–	R23	255	7807-7567-01
HL 300					
	BE	–	R32	400	7803-7549-01
HL 300S					
	BO,TU	–	R28	245	7809-7547-01
	BO,TU	–	R32	245	7803-7547-01
RD314					
	UG	–	R32	205	7803-7663-01
	UG	–	T38	410	7304-7672-01
L400, L410, L500, L510, L550					
	BO, PD, TU	10	R32	380	7803-3602-30
HLR 438L and HLR 438T					
	BE, TU	12.7	R32	380	7803-4700-50
	BE, TU	12.7	T38	400	7304-4700-50

- 38 = For 38 mm front head, S=For underground drilling

SHANK ADAPTERS

Sandvik

	Applica- tion	Flushing hole (mm)	Thread	Length (mm)	Part No.
HLR 438LS, 438TS, HL 538, HL538L, L550S					
	BE, PD, TU	–	R32	450	7803-4700-01
	TU	–	R38	450	7804-4700-01
	BE, PD, TU	–	T38	455	7304-4700-01
	BE	–	T38	545	7304-4706-01
HLR 438LS, HL500-38/HL510-38, HL538L, L550S					
	BE	–	R32	550	7803-7535-02
	BE	–	T35	550	7307-7535-02
	BE	–	T38	550	7304-7535-02
	BE	–	R38	550	7804-7535-02
HL 500-45 / HL510-45					
	BE	–	R32	550	7803-7557-01
	BE	–	T35	550	7307-7557-01
	BE	–	T38	550	7304-7557-01
	BE	–	T45	550	7305-7557-01
HL 500 S-38 / 510 S-38 / 510 B / 510 LH					
	PD,TU	–	R32	460	7803-7531-01
	TU	–	R38	460	7804-7531-01
	PD,TU	–	T38	460	7304-7531-01
	TU	–	R38	500	7804-7536-01
	PD,TU	–	T38	500	7304-7536-01
HL 500 F / HL510 F					
	B0	–	R32	350	7803-7553-01
HL 550 SUPER / HL560 SUPER / HL510 S-45					
	TU	–	T35	460	7307-7566-01
	PD,TU	–	T35	550	7307-7557-01
	TU	–	R38	500	7804-7554-01
	TU	–	T38	500	7304-7554-01

- 38, -45 = For 38 or 45 mm front head, S=For underground drilling

SHANK ADAPTERS

Sandvik

	Applica- tion	Flushing hole (mm)	Thread	Length (mm)	Part No.
HLX 5 / HLX 5T					
	TU	–	R32	500	7803-7585-01
	TU	–	T35	500	7307-7585-01
	TU	–	T38	500	7304-7585-01
	TU	–	R38	500	7804-7585-01
	BE	–	R32	575	7803-7586-01
	BE	–	T35	575	7307-7586-01
BE	–	T38	575	7304-7586-01	
BE	–	T45	575	7305-7586-01	

HFX 5T					
	TU	–	T38	720	7304-7668-01
	TU	–	T35	720	7307-7668-01

HLX5 PE-45					
	TU	–	R32	575	7803-7664-01
	TU	–	T38	575	7304-7664-01
	TU	–	T35	575	7307-7664-01
	TU	–	T38	720	7304-7671-01
	TU	–	T35	720	7307-7671-01

RD520/RD525 - PE					
	TU	–	T38	745	7304-7673-01
	TU	–	T35	745	7307-7673-01

RD520/RD525					
	TU	–	T38	525	7304-7669-01
	TU	–	T38	600	7304-7666-01
	TU	–	T35	600	7307-7666-01
	TU	–	T38	745	7304-7685-01
	TU	–	T35	745	7307-7685-01
	TU	–	R32	745	7803-7685-01

- 38, -45 = For 38 or 45 mm front head, S=For underground drilling

SHANK ADAPTERS

Sandvik

	Applica- tion	Flushing hole (mm)	Thread	Length (mm)	Part No.
HL 600-45 / HL 600 S-45					
	BE	–	R32	600	7803-7532-01
	BE	–	T38	600	7304-7532-01
	Tubes, BE	–	T45	600	7305-7532-01
	TU,PD	–	T38	525	7304-7537-01
	TU,PD	–	T45	525	7305-7537-01
HL 600-52					
	BE	–	T45	650	7305-7551-01
	BE	–	T51	650	7306-7551-02
HL 645					
	BE	–	T38	600	7304-7541-02
	BE	–	T45	600	7305-7541-02
HL700/HL710-45/HL800T-45/HL810T-45/HF810T-45/HL650-45					
	BE	–	T38	600	7304-7576-01
	BE	–	T45	600	7305-7576-01
HL700/HL710-52/HL710PE-52/HL700LH/HL710S-52/HL710SPE-52/T45/HL650-52/HL800T-52/HL800T/PE-52/HL810T-52/HF810T-52					
	BE,PD	–	T38	600	7304-7577-02
	BE	–	T45	600	7305-7577-02
	BE	–	T51	600	7306-7577-03
HL 850S					
	BE, PD	–	T45	670	7305-7400-01
	BE, PD	–	T51	670	7306-7400-02

-45, -52 = For 45 or 52 mm front head, PE= For Power Extractor rock drill (reverse hammering), S=For underground drilling

SHANK ADAPTERS

Sandvik

	Applica- tion	Flushing hole (mm)	Thread	Length (mm)	Part No.
HL1000/HL 1010, HL1000S/HL 1010S-52					
	BE	–	T45	670	7305-6010-01
	BE	–	T51	670	7306-6010-02
	PD	–	T45	590	7305-6008-01
	PD	–	T51	590	7306-6008-01
HL 1000-60/HL 1010-60					
	BE	–	T51	670	7306-6014-02
	BE	–	GT60	670	7600-6014-02
	BE	–	ST58	670	7358-6014-01
HL 1000-80/HL 1010-80, Shoulder drive					
	BE	–	GT60	760	7600-6031-01
HL1000/HL 1000S-80, HL1000-80/HL1010-80					
	PD	–	ST58	635	7328-6009-02
	PD	–	ST68	640	7329-6009-02
HL1000PE-65, HL1010PE-65, HL1060T/PE-65, HL1500T/PE-65, HL1560T/PE-65					
	BE,	–	T51	760	7306-6025-02
	BE,	–	GT60	760	7600-6025-02
	BE,	–	ST58	760	7358-6025-02

-52, -60, -65, -80 = For 52, 60, 65 or 80 mm front head, PE= For Power Extractor rock drill (reverse hammering), S=For underground drilling

SHANK ADAPTERS

Sandvik

	Applica- tion	Flushing hole (mm)	Thread	Length (mm)	Part No.
--	------------------	--------------------------	--------	----------------	----------

HL 1500-52 / 1500 T-52



BE	–		T51	710	7306-6021-02
----	---	--	-----	-----	--------------

HL 1500-60 / 1500 T-60



BE	–		T51	760	7306-6022-02
BE	–		GT60	760	7600-6022-03

HL 1500-80/1560T-80/HL1060T-80/HF1560, Shoulder drive



BE	–		GT60	760	7600-6030-05
BE			ST68	630	7329-6034-05
PD	–		ST58	635	7328-6020-01
PD	–		ST68	635	7329-6020-05

HL1500T/PE-90/HL1500ST/PE-90/ HL1560T/PE-90/HL1560ST/PE-90



PD	–		ST58	635	7328-6035-01
PD	–		ST68	635	7329-6035-05
BE	–		GT60	760	7600-6032-05

i -52, -60, -80, -90 = For 52, 60, 80 and 90 mm front head, PE= For Power Extractor rock drill, S=For underground drilling, T= Drill with stabilizer

SHANK ADAPTERS

Sandvik

	Applica- tion	Flushing hole (mm)	Thread	Length (mm)	Part No.
Hydrastar 200					
	TU,B0	–	R32	351	7803-4703-01
Hydrastar 200, 300 and X2					
	TU	–	R32	485	7803-3590-03
	TU	–	R38	485	7804-3590-03
	TU	–	T38	485	7304-3590-03
Hydrastar 350					
	BE	–	R32	500	7803-3591-01
	TU	–	R38	485	7804-3590-03
	BE	–	T38	500	7304-3591-01
Toyo PR 220					
	BE	14	R32	330	7803-7500-61
	BE	14	T38	446	7304-7500-60
Toyo TH 501					
	BE	11	T38	565	7304-7583-40

SHANK ADAPTERS

Atlas Copco

	Applica- tion	Flushing hole (mm)	Thread	Length (mm)	Part No.
--	------------------	--------------------------	--------	----------------	----------

Atlas Copco BBC 43, 44, 45 and 100

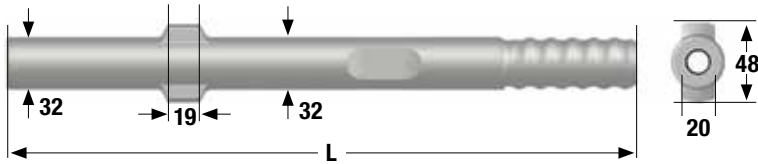

TU	10	R32	380	7803-3100-30
----	----	-----	-----	--------------

Atlas Copco BBC 51, 52, 54 and 120



TU	10	R32	380	7803-4200-30
TU	10	T38	390	7304-4200-30

Atlas Copco BBE 57



BE	14	T38	537	7304-7502-60
----	----	-----	-----	--------------

Atlas Copco COP 125, 130 and 131



TU, BE, PD	14	T38	380	7304-4500-60
------------	----	-----	-----	--------------

Atlas Copco COP 1032 HD







TU, B0	-	R32	340	7803-3588-01
--------	---	-----	-----	--------------

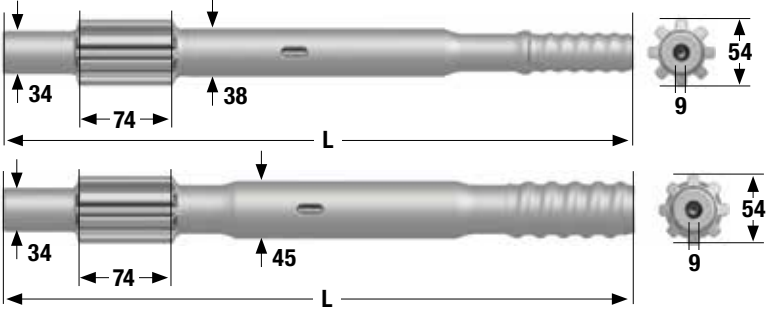

TU, B0	-	R38	340	7804-3575-01
--------	---	-----	-----	--------------

SHANK ADAPTERS

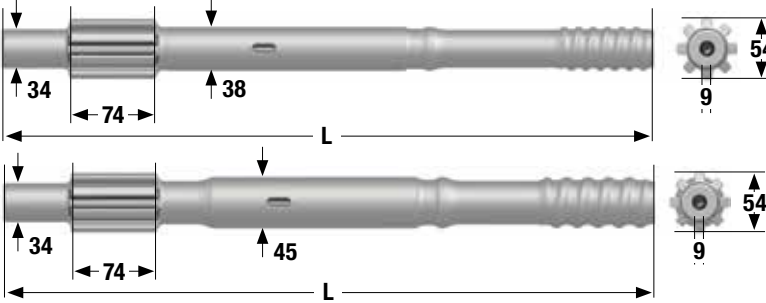
Atlas Copco

	Applica- tion	Flushing hole (mm)	Thread	Length (mm)	Part No.
Atlas Copco COP 1032 LE					
	BE,DS	-	R32	550	7803-3576-01
Atlas Copco COP 1036/1038 HB					
	BE	-	R32	500	7803-3591-01
	BE	-	T38	500	7304-3591-01
	BE	-	T45	500	7305-3591-01
Atlas Copco COP 1038 HD/1238					
	TU	-	R32	485	7803-3590-03
	TU	-	R38	485	7804-3590-03
	TU	-	T38	485	7304-3590-03
Atlas Copco COP 1038 HL					
	BE,PD	-	R32	575	7803-3593-01
	BE,PD	-	T38	575	7304-3593-01
	BE,PD	-	T45	575	7305-3593-01
Atlas Copco COP 1132					
	PD	-	R32	410	7803-3581-01
	PD	-	R32	500	7803-3583-01

SHANK ADAPTERS

Atlas Copco

	Applica- tion	Flushing hole (mm)	Thread	Length (mm)	Part No.
--	------------------	--------------------------	--------	----------------	----------

Atlas Copco COP 1238

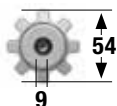

BE	–		R32	500	7803-3591-01
BE	–		T38	500	7304-3591-01
TU	–		R38	485	7804-3590-03
TU	–		T38	485	7304-3590-03

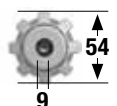

BE	–		T45	500	7305-3591-01
----	---	--	-----	-----	--------------

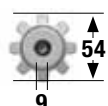

BE,PD	–		R32	575	7803-3593-01
BE,PD	–		T35	575	7307-3593-01
BE,PD	–		T38	575	7304-3593-01

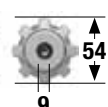

BE,PD	–		T38	575	7304-3550-01
BE,PD	–		T45	575	7305-3593-01

Atlas Copco COP 1432, COP 1532, COP1440, COP1838 HD/ME

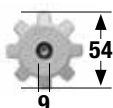

TU	–		R38	435	7804-3652-01
TU	–		T35	435	7307-3652-01
TU	–		T38	435	7304-3652-01
TU	–		R32	435	7803-3652-01

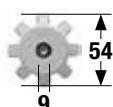

BO	–		R32	525	7803-3656-01
BE	–		T35	525	7307-3656-01
BO	–		T38	525	7304-3656-01

Atlas Copco COP 1432 Female



TU	–		R38	341	7804-3670-02
TU	–		R32	341	7803-3670-02

SHANK ADAPTERS

Atlas Copco

	Applica- tion	Flushing hole (mm)	Thread	Length (mm)	Part No.
Atlas Copco COP 1550, COP 1838 ME/ HE					
	BE,PD	–	T38	525	7304-3655-01
	BE,PD	–	T45	525	7305-3655-01
	BE,PD	–	T51	525	7306-3655-02
Atlas Copco COP 1550 EX, COP 1838 EX					
	BE	–	T38	730	7304-3825-02
	BE	–	T45	730	7305-3826-02
Atlas Copco COP 1840 HE, COP 1850					
	BE,PD	–	T35	565	7307-3690-01
	BE,PD	–	T38	565	7304-3690-02
	BE,PD	–	T45	565	7305-3690-02
	BE,PD	–	T51	565	7306-3690-03
Atlas Copco COP 2150, COP 2550					
	BE	–	T51	770	7306-3692-01
Atlas Copco COP 2160, COP 2560					
	BE	–	T51	770	7306-3689-01
Atlas Copco COP2160EX/2560EX					
	BE	–	T51	770	7306-3699-01
	BE	–	GT60	770	7600-3699-01
Atlas Copco COP 3038					
	TU	–	T38	435	7304-3666-01
	TU	–	T45	435	7305-3667-01
	TU	–	T35	440	7307-3668-01
	TU,PD	–	T35	525	7307-3671-01

SHANK ADAPTERS

Atlas Copco/Boart

	Applica- tion	Flushing hole (mm)	Thread	Length (mm)	Part No.
--	------------------	--------------------------	--------	----------------	----------

Atlas Copco COP 4050 MUX

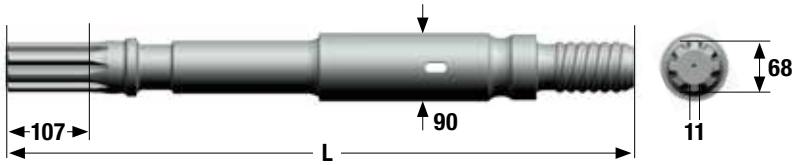

PD	–	ST68	835	7329-3720-01
PD	–	ST58	835	7328-3720-01

Boart HD 125, HD 150, HD 160



TU	–	R38	495	7804-4993-01
TU	–	T38	495	7304-4993-01

SHANK ADAPTERS

Furukawa

	Applica- tion	Flushing hole (mm)	Thread	Length (mm)	Part No.
Furukawa M 120 and PD 200					
	BE	14	R32	330	7803-7500-61
	BE	14	T38	380	7304-7543-60
	BE	14	T38	446	7304-7500-60
Furukawa PD 200R					
	BE	14	T38	484	7304-7581-60
Furukawa HD 260, HD 300					
	BE	16	T38	655	7304-7526-80
	BE	16	T45	655	7305-7526-80
Furukawa HD 609					
	BE	-	T38	620	7304-4791-01
	BE	-	T38	690	7304-4780-01
	BE	-	T45	620	7305-4791-01
Furukawa HD 612					
	BE	-	T45	710	7305-7414-01
Furukawa HD 709					
	BE	-	T38	620	7304-7426-01
Furukawa HD 712					
	BE	-	T45	788	7305-7417-01

SHANK ADAPTERS

Gardner-Denver, Ingersoll-Rand and Klemm

	Applica- tion	Flushing hole (mm)	Thread	Length (mm)	Part No.
--	------------------	--------------------------	--------	----------------	----------

Gardner-Denver PR 123

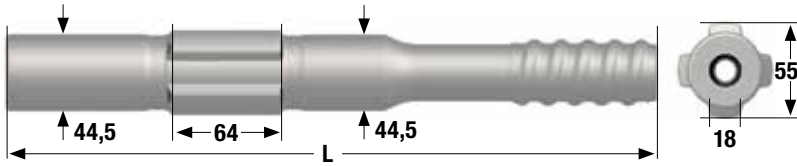

TU, BE	14	R32	330	7803-7500-61
TU, BE	14	R32	380	7803-7543-60
TU	14	R38	350	7804-7500-60
TU, BE	14	T38	446	7304-7500-60
TU, BE	14	T38	380	7304-7543-60

Ingersoll-Rand URD 475, URD 550, VL120, EVL 130, VL140 and F16



BE	14	R32	330	7803-7500-61
BE	14	R32	380	7803-7543-60
BE	14	T38	380	7304-7543-60
BE	14	T38	446	7304-7500-60

Ingersoll-Rand YH 65, YH 80

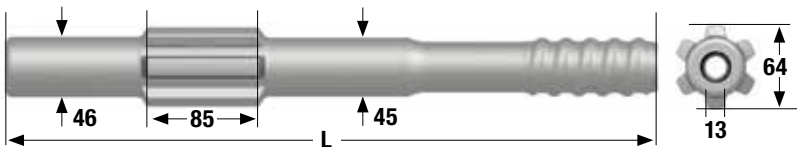

BE	19	T38	495	7304-7525-19
BE	19	T45	500	7305-7525-19

Ingersoll-Rand YH 80 A

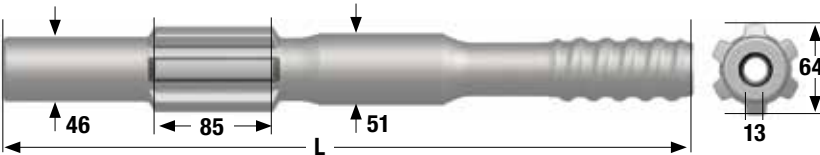

BE	19	T45	495	7305-7559-19
----	----	-----	-----	--------------

Ingersoll-Rand YH 65 RP, YH 70 RP, YH 75 RP, YH 80 RP

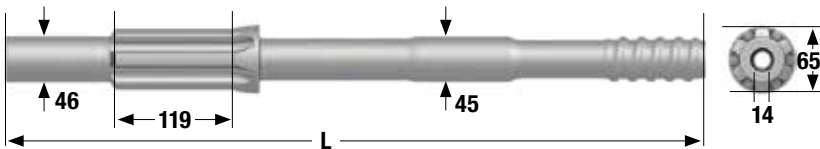

BE	19	T45	700	7305-7546-19
----	----	-----	-----	--------------

Klemm 4053

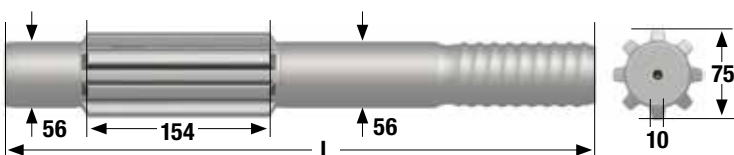

BE	–	R55	500	7805-6015 ¹⁾
BE	–	R55	500	7805-7015 ²⁾

 ¹⁾ LH-Rotation
²⁾ RH-Rotation

SHANK ADAPTERS

Montabert

	Applica- tion	Flushing hole (mm)	Thread	Length (mm)	Part No.
Montabert HC40					
	BE	–	R32	447	7803-4725-01
	BE	–	R38	447	7804-4725-01
	BE	–	T38	447	7304-4725-01
Montabert HC40 (female)					
	TU, BO	–	R32	270	7803-4726-01
Montabert HC 80, HC 90, HC 105					
	TU	–	R38	440	7804-4720-01
	TU	–	T38	440	7304-4720-01
Montabert H 100					
	BE	14	T38	537	7304-7502-60
Montabert HC 80R, HC 105R, HC 107R, HC 108R, HC 109R					
	BE	–	T38	670	7304-7544-01
Montabert HC 80, HC 120					
	BE	–	T45	490	7305-7520-01
Montabert HC 120R, HC 150R, HC 155R, HC 158R					
	BE	–	T51	670	7306-7528-02
Montabert HC 200A					
	BE	–	T51	840	7306-7530-02
	BE	–	GT60	840	7600-7530-02

SHANK ADAPTERS

SIG

	Applica- tion	Flushing hole (mm)	Thread	Length (mm)	Part No.
--	------------------	--------------------------	--------	----------------	----------

SIG HBM 50, 100 and 120



B0	-		R32	340	7803-3588-01
----	---	--	-----	-----	--------------

SIG HBM 100 and 120



TU, B0	-		R38	340	7804-3575-01
--------	---	--	-----	-----	--------------

SIG HBM 50, 100 and 120



BE, DS	-		R32	550	7803-3576-01
--------	---	--	-----	-----	--------------

SIG 101



BE	-		R32	500	7803-3591-01
----	---	--	-----	-----	--------------



WHEN EVERY MINUTE COUNTS, “THE RIGHT TOOLS FOR THE RIGHT JOB”

Auxiliary tools are an important part of the drilling application; that’s why we apply top grade tools to keep the process going and avoid further downtime. Sandvik accessories for Top Hammer Drilling tools are simple, practical additions. Their purpose is to enable the tool system to be tailored to meet different demands in different applications and working environment. Additional, Sandvik auxiliary tools optimize the system providing higher productivity, reliability and lower operating costs with minimal enviromental impact.

BIT ADAPTERS	96
REDUCTION COUPLINGS	96
WRENCHES	97
KNOCK-OFF TOOLS / FISHING TOOLS	97
THREAD GREASE AND GAUGES	98
DRILL STEEL STRAIGHTENER	98

AUXILIARY TOOLS

Bit adapters

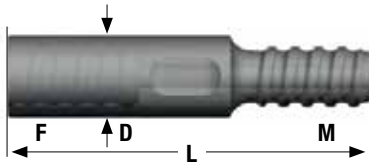

Wrench flat (mm)	Threads		Dimensions				Part No.
	F (Female)	M (Male)	L (mm)	L (in)	D (mm)	D (in)	
28,5	R23	R32	200	7 7/8"	35	1 3/8"	7837-3301
38	R25	R32	173	6 13/16"	45	1 3/4"	7832-3301
38	R28	R32	230	9 1/16"	40	1 37/64"	7839-3301
38	R32	T38	225	8 55/64"	45	1 49/64"	7833-4401
38	R32	R38	225	8 55/64"	45	1 49/64"	7833-4301
38	T35	T38	250	9 27/32"	48	1 7/8"	7337-4401
44,5	R38	R32	270	10 41/64"	55	2 5/32"	7834-3303
44,5	R38	T38	245	9 21/32"	55	2 5/32"	7834-4401
44,5	T38	R32	270	10 41/64"	57	2 1/4"	7334-3301
44,5	T38	T45	285	11 7/32"	57	2 1/4"	7334-5401
44,5	T38	R38	280	11 1/32"	57	2 1/4"	7334-4301
38	T45	T38	265	10 7/16"	63	2 31/64"	7335-4401
44,5	T45	T51	285	11 7/32"	63	2 31/64"	7335-6401
44,5	T51	T45	285	11 7/32"	71	2 51/64"	7336-5401

Reduction couplings

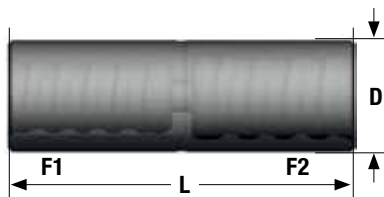

Threads		Dimensions				Part No.
F1	F2	L (mm)	L (in)	D (mm)	D (in)	
R32	R28	165	6 1/2"	44	1 47/64"	7993-0444
R32	R25	160	6 1/4"	43	1 11/16"	7993-2443
R38	R32	170	6 3/4"	55	2 5/32"	7994-3455
T38	R32	195	7 11/16"	55	2 5/32"	7314-3555
T38	R38	185	7 9/32"	55	2 5/32"	7314-4455
T38	T45	180		58	2 9/32"	7314-6258
T38	T45	180	8 43/64"	61	2 13/32"	7314-6261
T51	T45	218	8 19/32"	71	2 51/64"	7316-6271

AUXILIARY TOOLS

Wrenches and knock-off tools	Dimensions					Part No.
	L (mm)	L (ft)	L (in)	D (mm)	D (in)	

For integral drill steels and shank rods

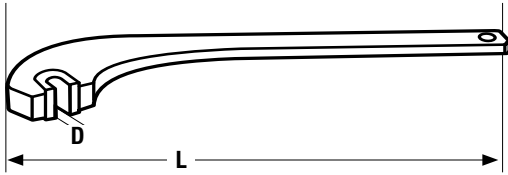

Hex 22	600	1'	11 5/8"	22	7/8"	795-1408
--------	-----	----	---------	----	------	----------

For extension rods

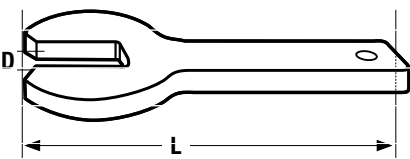

Hex 25, Round 32	300	-	11 13/16"	25	1"	795-1431
Hex 32, Round 39	370	1'	2 9/16"	32	1 1/4"	795-1432
Round 46	370	1'	2 9/16"	38	1 1/2"	795-1494
DTH	380	1'	2 31/32"	65	2 7/12"	795-1495

Knock-off-tools for Hex 22 and Hex 25

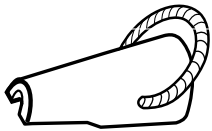

Pilot rods, type 7922-XXXX-XX	-	-	-	-	-	795-1469
-------------------------------	---	---	---	---	---	----------

Knock-off-tools for tapered bits



Hex 22	-	-	-	-	-	795-1467
--------	---	---	---	---	---	----------

Fishing tools	Dimensions				Part No.
	D	D1	L	Thread	

Fishing sleeve

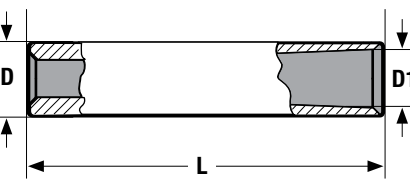

R32 round/Hex. rods/coupling sleeves	49	47,2	300	R32	795-1604A
R38 round rods/coupling sleeves	60	-	353	R38	795-1605
T35 round rods/coupling sleeves	52	50	284	T35	795-1613
T38 round rods/coupling sleeves/MF-rods	61	58,2	353	T38	795-1607A
T45 round rods/coupling sleeves/MF-rods	71	68	393	T45	795-1608
T51 round rods/coupling sleeves/MF-rods	82	78,2	440	T51	795-1609A
GT60 rods	92	87,5	450	GT60	795-2601
ST68 tubes Ø87	102	92	410	ST68	795-1696

Fishing pike

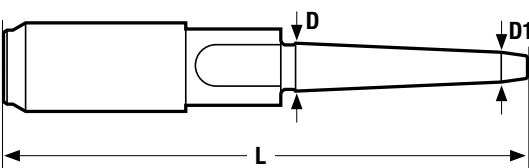

R32 rods ¹⁾	19,4	4	280	R32	795-1606
T38 rods ²⁾	19,4	8	237	T38	795-1676
T45 rods ²⁾	25	8	275	T45	795-1681
T51 rods ²⁾	27	15	285	T51	795-1690
ST58 tubes Ø76 ²⁾	57	22	400	ST58	795-1699
ST68 tubes Ø87 ²⁾	71	35	431	ST68	795-2600
GT60 rods	50	19,6	500	GT60	795-2604

¹⁾ Without flushing hole

²⁾ With flushing hole

AUXILIARY TOOLS

Thread grease	Dimensions			Part No.
	D (mm)	L (mm)	Weight (kg)	

For integral drill steels and shank rods



Can	215	170	4,5	795-1960
Can	300	380	18	795-1961
Tube	53/57	235	0,4	795-1962
Low temp. Can	300	380	18	795-1963
Barrel	370	690	50	795-1967
Barrel	610	870	240	795-1964

Gauges	Dimensions	Part No.
--------	------------	----------

Gauges / Wear gauge for male and female threads

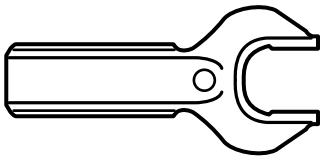

R22	795-1331
R25	795-1332
R32	795-1333
R38	795-1334

Gauges / Chuck wear gauge

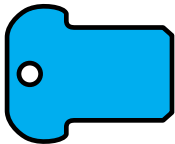

Hex 19	795-2301-19
Hex 22	795-2301-22
Hex 25	795-2301-25

Drill steel straightener	Prod. Info	Part No.
--------------------------	------------	----------

Drill steel straightener for Hex19 to Round 52

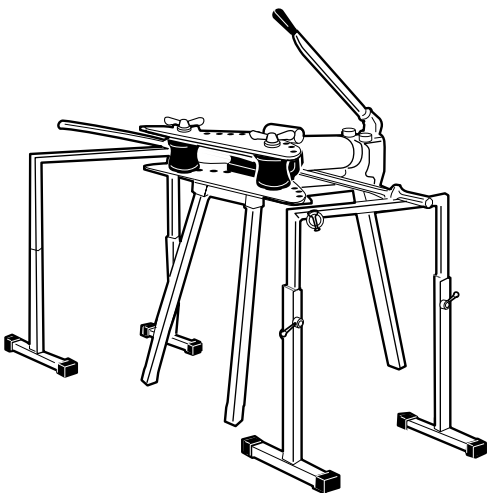

Manual/Hydraulic	796-2930
Electric/Hydraulic, 380V/50Hz	796-2930-52
Support leg, 1 piece	796-2931

INFORMATION

Grinding of Hardmetal – Health and Safety Information

Material Composition

Hardmetal products contain tungsten carbide and cobalt.

Routes of exposure

Grinding or heating hardmetal blanks or hardmetal products will produce dusts or fumes with dangerous ingredients that can be inhaled, swallowed or come in contact with the skin or eyes.

Acute toxicity

The dust is toxic by inhalation. Inhalation may cause irritation and inflammation in the airways. Skin contact can cause irritation and rash. Sensitized persons may experience an allergic reaction.

Chronic toxicity

Repeated inhalation of aerosols containing cobalt may cause obstruction in the airways. Prolonged inhalation of increased concentrations may cause lung fibrosis or lung cancer. Epidemiological studies indicate that workers exposed in the past to high concentrations of tungsten carbide/cobalt carried an increased risk of developing lung cancer.

Cobalt and nickel are potent skin sensitizers. Repeated or prolonged contact can cause sensitization.

Classification

- Following hazard classification according to GHS/CLP applies to the hardmetal powder ($2.5\% \leq \text{Co} < 25\%$):
- Acute Inhalation 3, H331: Toxic if inhaled
- Carc. Cat. 2, H351: Suspected of causing cancer by inhalation
- Repr. 2, H361; Suspected of damaging fertility.
- STOT RE 1, H372: Causes damage to lungs through prolonged or repeated exposure by inhalation
- Resp. Sens. 1B, H334 : May cause allergy or asthma symptoms or breathing difficulties if inhaled
- Skin Sens.1, H317: May cause an allergic skin reaction
- Eye Irrit. 2, H319: Causes serious eye irritation
- Aquatic Acute 1, H400: Very toxic to aquatic life
- Aquatic Chronic 2, H411: Toxic to aquatic life with long lasting effects

Precautionary Statements

- Do not breathe dust
- Wear protective gloves/protective clothing/eye protection.
- Use personal protective equipment as required. In case of inadequate ventilation wear respiratory protection
- Avoid release to the environment
- IF INHALED: If breathing is difficult, remove victim to fresh air and keep at rest in a position comfortable for breathing. If experiencing respiratory symptoms: Call a POISON CENTER or doctor/physician
- If skin irritation or rash occurs: Get medical advice/attention

CODE KEY INTEGRAL DRILL STEELS

7XX - YYZZ - QQ

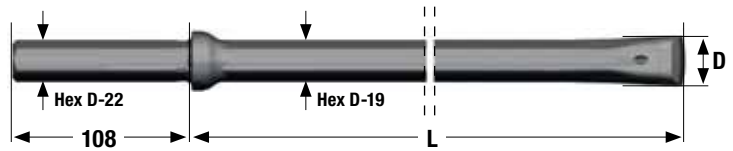

Main code 7XX	Sub code YYZZ	3:rd code group QQ
714 = 22x108 shank, Hex 22 chisel	YY = effective length in dm ZZ = bit diameter in mm	50 = insert height 17 mm 65 = insert height 19 mm
724 = 19x108 shank, Hex 19 chisel	YY = effective length in dm ZZ = bit diameter in mm	
728 = 22x108 shank, Hex 19 chisel	YY = effective length in dm ZZ = bit diameter in mm	

CODE KEY TAPERED BITS

7XXX - YYZZ - QQ



Main code 7XX	Sub code YYZZ	3:rd code group QQ
7770 = 12deg Long skirt 7776 = 11deg 7788 = 7deg 7795 = 12deg Short skirt	YY = 19, 3 gauge buttons YY = 44/52 Normal, 5 gauge buttons YY = 54, 6 gauge buttons YY = 64 Normal, 4 gauge buttons YY = 90 Cross bit HD ZZ = Bit diameter in mm	(Q) = S spherical buttons (Q) = B ballistic buttons QQ = 42 CC-grade 442 (inserts) QQ = 48 CC-grade XT48 (buttons)

CODE KEY TAPERED RODS

7XXX - YYZZ - QQ

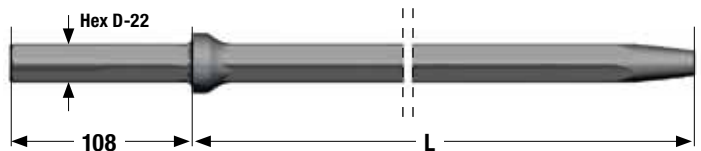

Main code 7XXX	Sub code YYZZ	3:rd code group QQ
7870 = 12deg 7876 = 11deg 7888 = 7deg	YY = 11 HF hardened, Sanbar 20 YY = 51 HF hardened, Sanbar 61 YY = 61 Carburized, Sanbar 64 ZZ = approximate length in dm	11 = no packing

CODE KEY EXTENSION RODS

7XXX – YYZZ – QQ

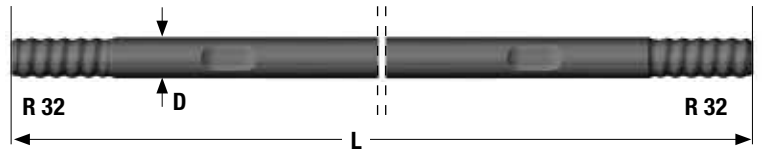

Main code 7XXX	Sub code YYZZ	3:rd code group QQ
7851 = R22 7852 = R25 7853 = R32 7854 = R38 7857 = R23	YY = 13 Hex22 YY = 23 Hex25 YY = 33 Round33 YY = 43 Round39 ZZ = approximate length in dm	20 = Carburized 30 = HF-hardened
7324 = T38 7325 = T45 7326 = T51	YY = 43 Round39 YY = 73 Round46 YY = 53 Round52 ZZ = approximate length in dm	20 = Carburized 30 = HF-hardened

CODE KEY MF RODS

7XXX – YYZZ – QQ

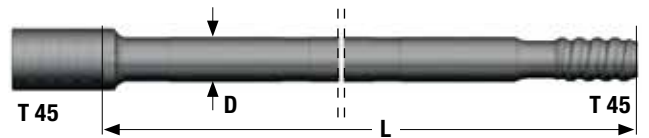

Main code 7XXX	Sub code YYZZ	3:rd code group QQ
7853 = R32 7857 = R23	YY = 48 Hex22 YY = 51 Round32 ZZ = approximate length in dm	20 = Carburized
7324 = T38 7325 = T45 7326 = T51 7327 = T35 7610 = GT60	YY = 47 Round39 YY = 77 Round46 YY = 55 Round52 YY = 11 Round60 YY = 14 Round60, for 92mm bits ZZ = approximate length in dm	20 = Carburized 70 = Sandvik Tough

CODE KEY DRIFTER RODS

7XXX – YYZZ – Q

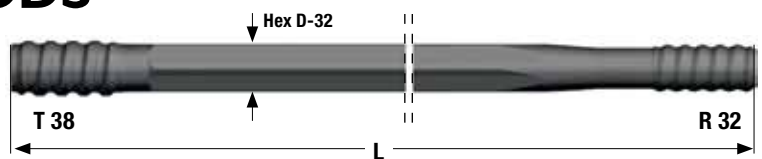

Main code 7XXX	Subcode YY ZZ = approximate length in dm	3:rd code group Q
7853 = R32 shank end 7854 = R38 shank end 7324 = T38 shank end 7327 = T35 shank end	Code	20 = Carburized
	24	Hex25 R25
	30	Hex28 R25
	76	Hex28 R28
	87	Hex32 R28
	65	MF-drifter Hex35 R32
	86	Hex32 R32
	96	Hex35 R32
	67	Hex35 α330
	70	Round39 α330
	72	Round39 R35
	85	Hex35 R35
	52	MF-drifter Round39 R35

CODE KEY SHANK RODS AND SHANK ADAPTERS

7XXX - YYZZ - QQ

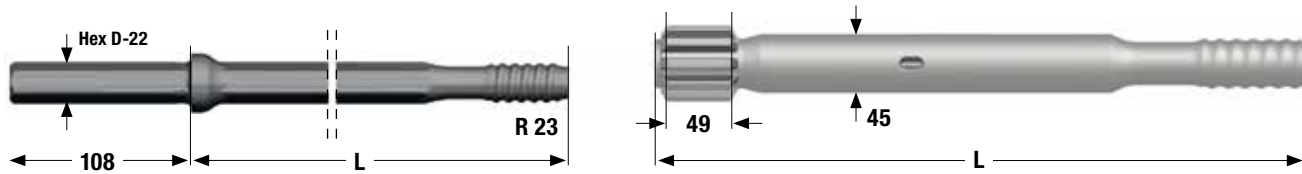

Main code 7XXX	Sub code YYZZ	3:rd code group QQ
7801 = R22 7802 = R25 7803 = R32 7804 = R38 7807 = R23 7814 = α250 7304 = T38 7305 = T45 7306 = T51 7307 = T35 7328 = ST58 7329 = ST68 7600 = GT60	Shank rods: YY = 61 Hex22 YY = 71 Hex25 ZZ = approximate length in dm	Shank rods: 11= shank H22X108, no packing 21=shank H25X159, no packing 30= Shank H25x108, no packing Shank adapters: 01,02,03,05 = separate flushing 19 = 19mm packing 23 = 23mm packing 30 = 10mm packing 40 = 11mm packing 50 = 12,7mm packing 60/61 = 14mm packing 80 = 16mm packing

CODE KEY DRIFTER BITS

7XXX - YYZZ - (Q) QQ

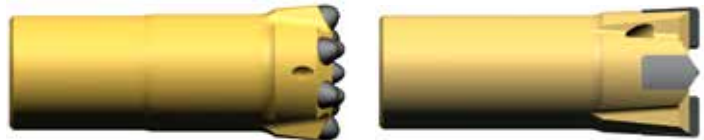

Main code 7XXX	Sub code YYZZ	3:rd code group QQ
7731 = R22 7732 = R25 7733 = R32 7737 = R23 7738 = R35 7739 = R28 7764 = α250 7767 = α330	YY = 10 Cross bit Normal YY = 13/14 Cross bit HD YY = 16 Normal bit with 6 gauge buttons YY = 44 Normal bit 5 gauge buttons YY = 52 HD bit 5 gauge buttons YY = 53 Normal bit 6 gauge buttons YY = 54 Normal bit 6 gauge buttons ZZ = Bit diameter in mm	(Q) = S spherical buttons (Q) = R ballistic buttons (Q) = C conical buttons QQ = 11 CC-grade 411 (inserts) QQ = 42 CC-grade 442 (inserts) QQ = 48 CC-grade XT48 (buttons) QQ = 55 CC-grade DP55 (buttons) QQ = 65 CC-grade DP65 (buttons)

CODE KEY BIG THREADED BITS

7XXX - YYZZ - (Q) QQ

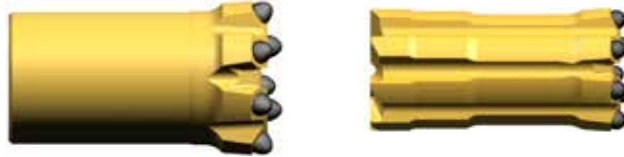

Main code 7XXX	Sub code YYZZ	3:rd code group QQ
7734 = R38 7514 = T38 7515 = T45 7516 = T51 7517 = T35 7620 = GT60	YY = 16 HD bit 6 gauge buttons YY = 18 HD bit 8 gauge buttons YY = 19 HD bit 9 gauge buttons YY = 26 Button bit Normal YY = 38 Button bit HD YY = 40 HD X-bit YY = 46 HD retrac bit 6 gauge buttons YY = 48 HD retrac bit 8 gauge buttons YY = 49 HD retrac bit 9 gauge buttons YY = 78 Retractable bit with buttons ZZ = Bit diameter in mm	(Q) = S spherical buttons (Q) = R ballistic buttons QQ = 11 CC-grade 411 (inserts) QQ = 42 CC-grade 442 (inserts) QQ = 48 CC-grade XT48 (buttons) QQ = 55 CC-grade DP55 (buttons) QQ = 65 CC-grade DP65 (buttons)

CODE KEY COUPLINGS

7XXX - YYZZ



Main code 7XXX	Sub code YYZZ
7991 = R22 7992 = R25 7993 = R32 7994 = R38 7314 = T38 7315 = T45 7316 = T51 7317 = T35	YY = 04 R28 adapter thread YY = 20 Tough hardened, same thread both ends YY = 24 R25 adapter thread YY = 33 Tough hardened, same thread both ends YY = 34/35 R32 adapter thread YY = 36 Carburized, same thread both ends YY = 44 R38 adapter thread YY = 52 T38 Adapter thread YY = 62 T45 adapter thread ZZ = Outer diameter in mm

CODE KEY BIT ADAPTERS

7XXX - YY0I



Main code 7XXX	Sub code YYZZ
7832 = R25 internal thread 7833 = R32 internal thread 7834 = R38 internal thread 7837 = R23 internal thread 7839 = R28 internal thread 7334 = T38 internal thread 7335 = T45 internal thread 7336 = T51 internal thread 7337 = T35 internal thread	YY = 33 R32 external thread YY = 43 R38 external thread YY = 44 T38 external thread YY = 54 T45 external thread YY = 64 T51 external thread

NUMERICAL INDEX WITH WEIGHT TABLE

Part No.	Weight (kg)	Page	Part No.	Weight (kg)	Page	Part No.	Weight (kg)	Page
714-0434-65	1,8	19	721-2020	0,8	25	7304-7526-80	6,3	89
714-0635-65	2,5	19	721-2420	0,8	25	7304-7531-01	4,0	78
714-0641-65	2,5	19	721-2820	0,9	25	7304-7532-01	5,9	80
714-0829	3,0	19	721-3120	1,0	25	7304-7535-02	4,6	78
714-0833-65	3,0	19	724-0424	1,3	18	7304-7536-01	4,3	78
714-0834-65	3,0	19	724-0429	1,3	18	7304-7537-01	5,5	80
714-0840-65	3,1	19	724-0627	1,7	18	7304-7541-02	6,6	80
714-1232-65	4,3	19	724-0823	2,1	18	7304-7543-60	3,6	89, 90
714-1234-65	4,3	19	724-0828	2,2	18	7304-7544-01	7,3	91
714-1240-65	4,3	19	724-1226	3,0	18	7304-7554-01	5,3	78
714-1628-50	5,4	19	724-1627	5,0	18	7304-7557-01	5,6	78
714-1631	5,5	19	724-2426	5,7	18	7304-7576-01	6,9	80
714-1633-65	5,5	19	728-0424	1,4	18	7304-7577-02	8,4	80
714-1639-65	5,5	19	728-0429	1,4	18	7304-7581-60	5,2	89
714-1833-65	6,1	19	728-0828	2,3	18	7304-7583-40	5,8	83
714-1839-65	6,1	19	728-1627	3,9	18	7304-7585-01	5,3	79
714-2030	6,5	19	7304-3550-01	5,4	86	7304-7586-01	5,7	79
714-2033-65	6,6	19	7304-3590-03	4,1	83, 85, 86	7304-7664-01	6,4	79
714-2427-50	7,9	19	7304-3591-01	4,8	83, 85, 86	7304-7666-01	6,5	79
714-2432-65	7,9	19	7304-3593-01	4,7	85, 86	7304-7668-01	7,0	79
714-2438-65	7,9	19	7304-3652-01	3,8	86	7304-7669-01	5,6	79
714-3231	10	19	7304-3655-01	6,2	87	7304-7671-01	7,7	79
714-3237-65	10	19	7304-3656-01	4,5	86	7304-7672-01	3,5	77
714-4030	13	19	7304-3666-01	3,9	87	7304-7673-01	7,0	79
714-4036-65	13	19	7304-3690-02	6,7	87	7304-7685-01	7,0	79
714-4829	15	19	7304-3825-02	9,9	87	7305-3591-01	5,1	85, 86
714-4835-65	15	19	7304-4200-30	3,0	84	7305-3593-01	5,8	85, 86
714-5628-50	18	19	7304-4500-60	2,8	84	7305-3655-01	6,5	87
714-5634-65	18	19	7304-4700-01	4,0	78	7305-3667-01	4,5	87
714-6427-50	20	19	7304-4700-50	3,3	77	7305-3690-02	6,9	87
714-6433-65	20	19	7304-4706-01	4,7	78	7305-3826-02	10	87
714-7226-50	23	19	7304-4720-01	3,8	91	7305-4791-01	6,3	89
714-7232-65	23	19	7304-4725-01	3,6	91	7305-6008-01	8,9	81
714-8026-50	25	19	7304-4780-01	6,4	89	7305-6010-01	9,7	81
714-8825-5005	27	19	7304-4791-01	6,0	89	7305-7400-01	9,1	80
714-9625-5005	30	19	7304-4993-01	5,5	88	7305-7414-01	8,9	89
721-1517	0,6	25	7304-7426-01	6,3	89	7305-7417-01	9,5	89
721-1620	0,7	25	7304-7500-60	4,0	83, 89, 90	7305-7520-01	5,6	91
721-1622	0,7	25	7304-7502-60	5,4	84, 91	7305-7525-19	5,5	90
721-1922	0,8	25	7304-7525-19	5,4	90	7305-7526-80	6,6	89

NUMERICAL INDEX WITH WEIGHT TABLE

Part No.	Weight (kg)	Page	Part No.	Weight (kg)	Page	Part No.	Weight (kg)	Page
7305-7532-01	6,3	80	7307-7671-01	7,4	79	7324-8637-20	26	36
7305-7537-01	5,8	80	7307-7673-01	7,0	79	7324-8643-20	28	36
7305-7541-02	6,9	80	7307-7685-01	7,0	79	7324-9631-20	24	36
7305-7546-19	7,8	90	7314-3355	2,0	52	7324-9637-20	28	36
7305-7551-01	7,6	80	7314-3555	2,3	96	7324-9643-20	32	36
7305-7557-01	5,9	78	7314-3652	1,6	36, 40, 41	7324-9649-20	37	36
7305-7559-19	6,1	90	7314-4455	1,9	96	7324-9655-20	42	36
7305-7576-01	7,2	80	7314-6258	2,0	96	7324-9661-20	44	36
7305-7577-02	8,7	80	7314-6261	2,9	96	7324-9664-20	46	36
7305-7586-01	6,2	79	7315-3663	2,7	54	7325-7331C-30	33	54, 56
7306-3655-02	6,8	87	7316-3671	3,7	56	7325-7337C-30	40	54, 56
7306-3689-01	11	87	7316-3676	4,6	56	7325-7343C-30	47	54, 56
7306-3690-03	7,2	87	7316-6271	4,0	96	7325-7712C-20	14	68
7306-3692-01	9,5	87	7324-4331C-30	24	52	7325-7715C-20	18	68
7306-3699-01	14	87	7324-4337C-30	29	52	7325-7718C-20	21	68
7306-6008-01	9,3	81	7324-4712C-20	11	66	7325-7731-70	35	54
7306-6010-02	10	81	7324-4715C-20	12	66	7325-7737-70	41	54
7306-6014-02	12	81	7324-4718C-20	15	66	7325-7743-70	48	54
7306-6021-02	11	82	7324-4731-70	25	52	7325-7761-70	70	54
7306-6022-02	13	82	7324-4737-70	30	52	7326-5515C-20	23	70
7306-6025-02	16	81	7324-4743-70	36	52	7326-5518C-20	27	70
7306-7400-02	8,9	80	7324-6537-20	29	36	7326-5537-70	50	56
7306-7528-02	8,9	91	7324-6543-20	34	36	7326-5543-70	57	56
7306-7530-02	16	91	7324-6731-20	25	39	7326-5561-70	87	56
7306-7551-02	8,1	80	7324-6737-20	29	39	7327-4718-20	16	64
7306-7577-03	8,8	80	7324-6743-20	34	39	7327-4731-20	25	43, 50
7307-3593-01	4,5	86	7324-6749-20	39	39	7327-4737-20	32	43, 50
7307-3652-01	3,7	86	7324-6755-20	44	39	7327-4743-20	35	43
7307-3656-01	4,2	86	7324-6931-20	18	52	7327-4749-20	40	43
7307-3668-01	4,5	87	7324-7049-20	44	39	7327-5243-20	35	43
7307-3671-01	4,9	87	7324-7055-20	50	39	7327-5249-20	40	43
7307-3690-01	6,9	87	7324-7061-20	57	39	7327-5255-20	45	43
7307-7535-02	4,5	78	7324-7064-20	57	39	7327-5261-20	50	43
7307-7557-01	5,6	78	7324-7243-20	35	41	7328-3720-01	26	88
7307-7566-01	4,9	78	7324-7249-20	40	41	7328-6009-02	17	81
7307-7585-01	5,3	79	7324-7255-20	45	41	7328-6020-01	17	82
7307-7586-01	5,6	79	7324-7261-20	49	41	7328-6035-01	22	82
7307-7664-01	6,4	79	7324-8543-20	34	41	7329-3720-01	27	88
7307-7666-01	6,5	79	7324-8549-20	37	41	7329-6009-02	17	81
7307-7668-01	7,0	79	7324-8555-20	42	41	7329-6020-05	18	82

NUMERICAL INDEX WITH WEIGHT TABLE

Part No.	Weight (kg)	Page	Part No.	Weight (kg)	Page	Part No.	Weight (kg)	Page
7329-6034-05	17	82	7515-1902-R48	4,0	53, 67	7528-7389-R65	4,5	72
7329-6035-05	22	82	7515-1902-S48	4,0	53, 67	7528-8489-R65	4,0	72
7334-3301	2,6	96	7515-2676A-S48	2,5	53, 67	7529-5604A-S65	30	73
7334-4301	3,4	96	7515-2689A-S48	3,1	53, 67	7529-5652C-S65	15	73
7334-5401	3,3	96	7515-4870-R48	2,7	53, 67	7529-6652-S48	9,0	73
7335-4401	2,9	96	7515-4876-R48	3,0	53, 67	7529-6902-S65	5,2	73
7335-6401	3,7	96	7515-4876-S48	3,0	53, 67	7529-7302-R65	5,5	73
7336-5401	3,8	96	7515-4889-R48	4,8	53, 67	7529-7315-R65	7,5	73
7337-4401	1,9	96	7515-4889-S48	4,8	53, 67	7529-8402-R65	5,2	73
7358-6014-01	13	81	7515-4902-R48	6,9	53, 67	7529-8415-R65	5,9	73
7358-6025-02	17	81	7515-4902-S48	6,8	53, 67	7600-3699-01	14	87
7378-7615-26	33	72	7515-5576A-C60	2,5	53, 67	7600-6014-02	13	81
7378-7618-26	41	72	7515-5627-S48	6,9	67	7600-6022-03	15	82
7379-8715-26	40	73	7515-5652-S48	9,0	67	7600-6025-02	17	81
7379-8715-46	40	73	7515-7876A-S48	3,0	53, 67	7600-6030-05	21	82
7379-8718-26	47	73	7515-7889A-S48	4,4	53, 67	7600-6031-01	21	81
7379-8718-46	48	73	7516-1889-R48	3,6	55, 69	7600-6032-05	24	82
7514-1664-R48	1,7	51, 65	7516-1889-S48	3,6	55, 69	7600-7530-02	17	91
7514-1664-S48	1,7	51, 65	7516-1902-R48	4,6	55, 69	7610-1137-70	73	58
7514-1870-S48	1,9	51, 65	7516-1902-S48	4,5	55, 69	7610-1143-70	86	58
7514-1876-R48	2,3	51, 65	7516-1915-S48	6,0	55, 69	7610-1161-70	120	58
7514-1876-S48	2,2	51, 65	7516-1927-S48	6,6	55, 69	7610-1243-70	92	58
7514-1889-S48	3,0	51, 65	7516-2602A-S48	4,3	55, 69	7610-1443-70	84	58
7514-2664A-S48	1,7	51, 65	7516-2689A-S48	3,6	55, 69	7620-1892-S48	5,2	57
7514-2676A-S48	2,3	51, 65	7516-4889-R48	4,3	55, 69	7620-1896-S48	5,3	57
7514-4064-11	2,1	51, 65	7516-4889-S48	4,5	55, 69	7620-1902-S48	6,5	57
7514-4664-S48	2,2	51, 65	7516-4902-R48	6,3	55, 69	7620-1915-S48	7,8	57
7514-4864-R48	2,0	51, 65	7516-4902-S48	6,3	55, 69	7620-1927-S48	9,4	57
7514-4870-S48	3,1	51, 65	7516-4915-R48	8,4	55, 69	7620-1940-S48	12	57
7514-4876-R48	3,5	51, 65	7516-4915-S48	8,3	55, 69	7620-1952-S48	14	57
7514-4876-S48	3,5	51, 65	7516-4927-S48	11	55, 69	7620-4902-S48	7,6	57
7514-5564A-C60	1,7	51, 65	7516-5652-S48	9,3	69	7620-4915-R48	9,4	57
7514-5576A-C60	2,2	51, 65	7516-7802-S48	5,7	55, 69	7620-4915-S48	9,6	57
7514-7864A-S48	2,2	51, 65	7516-7889A-S48	4,4	55, 69	7620-4927-S48	13	57
7514-7876A-S48	3,0	51, 65	7517-1654A-S48	1,0	50, 64	7620-4940-S48	16	57
7515-1870-S48	2,3	53, 67	7517-4654-R48	1,3	50, 64	7620-4952-S48	19	57
7515-1876-R48	2,5	53, 67	7517-4657-R48	1,5	50, 64	7620-8115-S55	9,8	57
7515-1876-S48	2,5	53, 67	7525-8476-R65	3,4	71	7620-8702-R48	8,0	57
7515-1889-R48	3,1	53, 67	7528-5652-S65	13	72	7620-8792-R48	6,1	57
7515-1889-S48	3,2	53, 67	7528-6989-S65	4,5	72	7620-8792-S48	6,1	57

NUMERICAL INDEX WITH WEIGHT TABLE

Part No.	Weight (kg)	Page	Part No.	Weight (kg)	Page	Part No.	Weight (kg)	Page
7620-8796-R48	7,0	57	7733-5348A-R48	0,9	35	7767-5345A-S48	0,8	38
7640-7653-70	112	58	7733-5348A-S48	0,9	35	7767-5348A-R48	0,9	38
7640-8743-70	106	58	7733-5443B-R48	0,7	35	7767-5348A-S48	0,9	38
7660-8743-71	104	58	7733-5445B-R48	0,8	35	7767-5443B-R48	0,7	38
7721-4802-S48	2,1	37, 40, 42	7733-5545A-C60	0,8	35	7767-5445B-R48	0,8	38
7721-4827-S48	3,6	37, 40, 42	7733-5551A-C60	0,8	35, 48, 62	7767-5602P-S48	3,2	40
7721-4889-S48	1,5	37, 40, 42	7733-5557A-C60	1,2	48, 62	7770-4433-B48	0,3	21
7722-4864-S48	0,9	20, 33, 34, 37	7733-5564A-C60	1,3	48, 62	7770-4435-B48	0,3	21
7722-4876-S48	1,3	20, 33, 34, 37	7733-5602P-S48	2,9	37	7770-5233-B48	0,3	21
7722-4889-S48	1,7	20, 33, 34, 37	7737-4433-R48	0,4	27	7770-5235-B48	0,3	21
7723-4802-S48	3,6	63, 66	7737-5235-R48	0,4	27	7770-5433-B48	0,2	21
7723-4827-S48	5,2	63, 66	7737-5238A-R48	0,4	27	7770-9030-42	0,3	21
7731-1038-42	0,5	26	7737-5241-R48	0,5	27	7770-9032-42	0,3	21
7732-1435-42	0,5	32	7737-5345-R48	0,5	27	7770-9035-42	0,4	21
7732-4433C-S48	0,4	32	7738-1448-42	1,0	41	7776-1938-B48	0,2	23
7732-4435-S48	0,4	28, 32	7738-1651A-R48	1,0	41	7776-1940-B48	0,3	23
7732-4437C-S48	0,5	32	7738-1651A-S48	0,9	41	7776-4432-B48	0,3	23
7732-5235-R48	0,4	28	7738-4654A1-R48	1,3	43	7776-4435-B48	0,3	23
7732-5238-R48	0,5	28, 32	7738-5348A-R48	1,0	41	7776-4436-B48	0,2	23
7732-5238-S48	0,5	28, 32	7738-5348A-S48	1,0	41	7776-4438-B48	0,3	23
7732-5241-R48	0,5	28	7738-5602P-S48	3,2	42	7776-4440-B48	0,3	23
7732-5241-S48	0,5	28, 32	7739-1438-42	0,6	34	7788-5232-B48	0,3	24
7732-5345F-R48	0,7	28	7739-5237-S48	0,5	34	7788-5233-B48	0,3	24
7733-1345A-42	0,8	35	7739-5238-R48	0,6	34	7788-5235-B48	0,4	24
7733-1451-42	1,1	48, 62	7739-5238-S48	0,6	34	7788-5238-B48	0,3	24
7733-1651A-R48	1,0	35, 48, 62	7739-5241-S48	0,6	34	7795-5232-B48	0,2	21
7733-1651A-S48	0,9	35, 48, 62	7739-5243-S48	0,7	34	7795-5235-B48	0,3	21
7733-1657A-S48	1,2	35, 48, 62	7764-5238-R48	0,5	29	7795-5238-B48	0,3	21
7733-1664-S48	1,7	35, 48, 62	7764-5345F-R48	0,7	29	7795-6428-B48	0,2	21
7733-1876-S48	1,8	35, 48, 62	7767-1345A-42	0,8	38	7795-6430-B48	0,2	21
7733-4651-R48	1,2	48, 62	7767-1651A-R48	1,0	38	7801-6103-11	1,1	26, 76
7733-4651-S48	1,2	48, 62	7767-1651A-S48	1,0	38	7802-6103-11	1,1	28, 76
7733-4864-S48	2,4	48, 62	7767-1664-S48	1,6	38	7802-6108-11	2,8	28
7733-5243A-S48	0,7	35	7767-1876-S48	1,7	38	7802-6110-11	3,5	28
7733-5245A-S48	0,8	35	7767-4651A-S48	1,1	38	7802-7103-14	1,4	76
7733-5248A-S48	0,9	35	7767-5243A-S48	0,7	38	7802-7103-21	1,6	76
7733-5251A-S48	1,0	35	7767-5245A-S48	0,8	38	7802-7567-01	1,0	77
7733-5343A-R48	0,7	35	7767-5248A-S48	0,8	38	7803-3100-30	2,0	84
7733-5345A-R48	0,8	35	7767-5343A-R48	0,7	38	7803-3576-01	4,8	85, 92
7733-5345A-S48	0,8	35	7767-5345A-R48	0,8	38	7803-3581-01	2,5	85

NUMERICAL INDEX WITH WEIGHT TABLE

Part No.	Weight (kg)	Page	Part No.	Weight (kg)	Page	Part No.	Weight (kg)	Page
7803-3583-01	3,0	85	7804-7536-01	4,4	78	7852-2331-20	12	28
7803-3588-01	3,4	84, 92	7804-7554-01	5,2	78	7853-2418-20	6,9	32
7803-3590-03	3,9	83, 85	7804-7585-01	5,3	79	7853-2421-20	8,4	32
7803-3591-01	4,1	83, 85, 86, 92	7805-6015	10	90	7853-2424-20	9,5	32
7803-3593-01	4,6	85, 86	7805-7015	10	90	7853-2426-20	10	32
7803-3602-30	2,1	77	7807-6103-11	1,1	27, 76	7853-2427-20	11	32
7803-3652-01	3,7	86	7807-6108-11	3,0	27	7853-2429-20	16	32
7803-3656-01	4,1	86	7807-6116-11	5,0	27	7853-2431-20	12	32
7803-3670-02	4,7	86	7807-6124-11	7,7	27	7853-2433-20	12	32
7803-4200-30	2,6	84	7807-6132-11	12	27	7853-2437-20	14	32
7803-4700-01	3,7	78	7807-6136-11	13	27	7853-3309-20	4,8	63
7803-4700-50	2,7	77	7807-7103-30	1,3	27, 76	7853-3312-20	6,3	63
7803-4703-01	3,7	83	7807-7136-30	18	27	7853-3315-20	8,0	63
7803-4725-01	3,3	91	7807-7567-01	1,0	77	7853-3318-20	9,8	63
7803-4726-01	2,8	91	7807-7570-01	0,9	77	7853-3324-30	13	49
7803-7500-61	3,0	83, 89, 90	7809-7547-01	2,7	77	7853-3331-30	16	49
7803-7531-01	3,9	78	7814-7136-30	14	29	7853-3337-30	20	49
7803-7532-01	5,7	80	7821-3440	2,8	37	7853-5109-20	5,5	63
7803-7535-02	4,2	78	7821-5440	2,7	42	7853-5112-20	7,5	63
7803-7543-60	4,1	90	7821-6740	2,7	40	7853-5115-20	9,1	63
7803-7547-01	2,6	77	7822-1526	1,9	34	7853-5118-20	11	63
7803-7549-01	2,6	77	7822-2526	1,3	33	7853-5131-20	18	49
7803-7553-01	3,9	78	7822-3526	1,5	37	7853-5137-20	21	49
7803-7557-01	5,4	78	7823-2647	4,6	66	7853-7624-20	12	34
7803-7585-01	5,1	79	7823-3647	4,4	63	7853-7627-20	14	34
7803-7586-01	5,4	79	7832-3301	1,2	96	7853-7631-20	15	34
7803-7663-01	2,0	77	7833-4301	1,8	96	7853-7637-20	20	34
7803-7664-01	5,7	79	7833-4401	1,9	96	7853-7643-20	21	34
7803-7685-01	7,0	79	7834-3303	2,5	96	7854-8631-20	20	36
7804-3575-01	4,1	84, 92	7834-4401	2,3	96	7854-8637-20	24	36
7804-3590-03	4,1	83, 85, 86	7837-3301	1,0	96	7854-8643-20	27	36
7804-3652-01	3,9	86	7839-3301	1,4	96	7854-8649-20	31	36
7804-3670-02	4,3	86	7851-1308-20	2,4	26	7854-9631-20	24	36
7804-4700-01	4,1	78	7851-1312-20	3,6	26	7854-9637-20	28	36
7804-4720-01	3,9	91	7851-1316-20	4,8	26	7854-9643-20	33	36
7804-4725-01	3,8	91	7852-2309-20	3,6	28	7854-9649-20	37	36
7804-4993-01	5,5	88	7852-2312-20	4,6	28	7854-9655-20	42	36
7804-7500-60	3,5	90	7852-2315-20	5,7	28	7857-4821-20	6,4	27
7804-7531-01	4,2	78	7852-2318-20	6,9	28	7857-4831-20	10	27
7804-7535-02	4,5	78	7852-2324-20	9,0	28	7870-1140-11	13	22

NUMERICAL INDEX WITH WEIGHT TABLE

Part No.	Weight (kg)	Page	Part No.	Weight (kg)	Page	Part No.	Weight (kg)	Page
7870-1144-11	14	22	795-1469	4,4	97	7985-6315-26	28	71
7870-1148-11	15	22	795-1494	3,5	97	7985-6318-26	32	71
7870-1156-11	18	22	795-1495	5,2	97	7991-2031	0,5	26
7870-1164-11	20	22	795-1604A	1,9	97	7992-2035	0,7	28
7870-1172-11	23	22	795-1605	3,9	97	7993-0444	1,2	96
7870-1180-11	25	22	795-1606	0,6	97	7993-2443	1,1	96
7870-1188-11	27	22	795-1607A	3,9	97	7993-3644	0,9	32, 34, 49, 63
7870-5124-11	7,9	22	795-1608	6,0	97	7994-3455	1,9	96
7870-5132-11	10	22	795-1609A	8,4	97	7994-3655	1,7	36
7870-6106-11	2,2	22	795-1613	1,7	97			
7870-6112-11	4,1	22	795-1676	0,9	97			
7870-6118-11	6,0	22	795-1681	1,5	97			
7870-6120-11	6,5	22	795-1690	2,0	97			
7870-6124-11	7,8	22	795-1696	11	97			
7870-6131-11	9,5	22	795-1699	4,9	97			
7870-6132-11	10	22	795-1960	4,9	98			
7870-6137-11	11	22	795-1961	18	98			
7876-6106-11	2,2	23	795-1962	0,6	98			
7876-6108-11	2,7	23	795-1963	18	98			
7876-6112-11	4,1	23	795-1964	240	98			
7876-6116-11	5,0	23	795-1967	50	98			
7876-6118-11	5,9	23	795-2301-19	0,0	98			
7876-6120-11	6,5	23	795-2301-22	0,0	98			
7876-6124-11	7,8	23	795-2301-25	0,0	98			
7876-6131-11	9,6	23	795-2600	6,6	97			
7876-6136-11	11	23	795-2601	10	97			
7888-6124-11	7,6	24	795-2604	10	97			
7888-6132-11	8,3	24	7953-4618-20	16	63			
7922-6108-11	3,3	20	7953-4631-20	24	49			
7922-6112-11	4,7	20	7955-5618-20	18	66			
7922-6120-11	7,0	20	7955-5637-20	48	52			
7922-6124-11	7,9	20	7956-6318-21	28	68			
795-1331	0,2	98	7956-6337-70	46	54			
795-1332	0,3	98	7956-7637-70	78	54			
795-1333	0,4	98	7957-7618-20	40	70			
795-1334	0,5	98	7957-7637-70	76	56			
795-1408	3,1	97	7957-8737-70	89	56			
795-1431	3,5	97	796-2930	50	98			
795-1432	3,5	97	796-2930-52	60	98			
795-1467	1,1	97	796-2931	5,0	98			

NOTES

A series of horizontal dotted lines for writing notes.



www.sandvik.com